

Technical Databook Car and Van Tyres 2009 · 2010

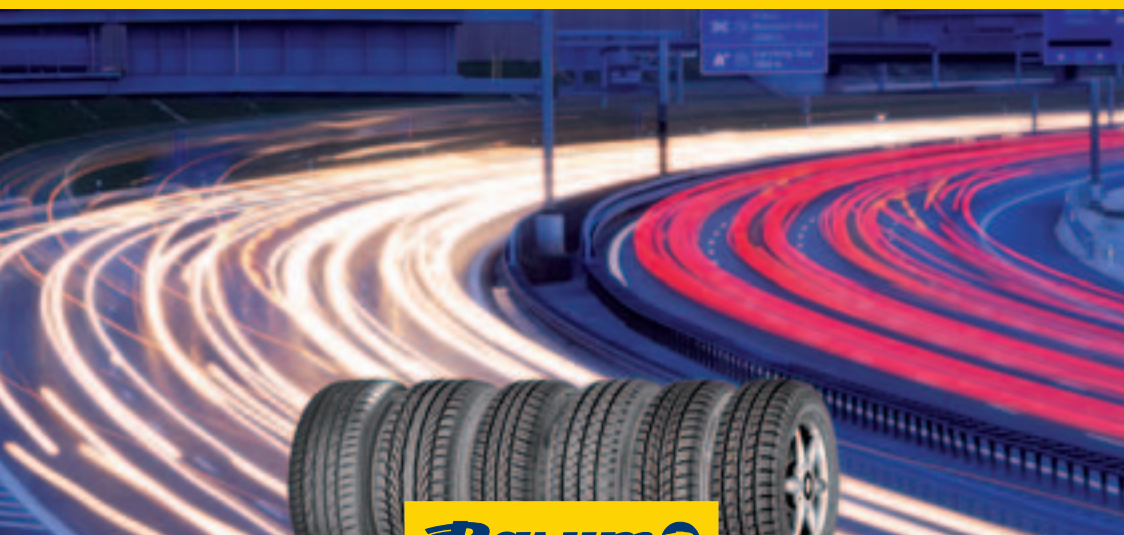

Barum 

This data book contains comprehensive information on Barum Car and Van Tyres. The technical data and other details on tyres and accessories have been compiled to reflect as exactly and completely as possible the current state of development and are based on **ETRTO**¹⁾, **ISO**²⁾ and **WdK/DIN**³⁾ standards.

Most of the Barum tyres comply with **DOT**⁴⁾ regulations and are marked accordingly.

They are homologated in accordance with the relevant **ECE**⁵⁾ regulation and are hence also homologated in accordance with current **EU**⁶⁾ tyre regulation.

This databook is intended for information and instruction only. No liability whatsoever will be accepted for damage, regardless of its nature and its legal basis, arising from advice given in this book.

Tyre safety tips

We recommend that the **inflation pressure** of every tyre is **checked** at least **every 14 days**. Avoid driving over sharp-edged or pointed objects.

Lower inflation pressures, greater loads or higher speeds than specified by the vehicle and/or tyre manufacturer all shorten the **service life** of tyres and can result in structural damages.

We recommend that **new tyres** are **run in** at moderate speeds for the first 120 to 190 miles (200 to 300 km) to roughen the tread surface. The tyre does not achieve its best performance until after this running-in period.

We recommend all wheel positions of a passenger car are fitted with tyres of the **same tread design**.

Please observe the detailed operating instructions on **page 41 ff.**

¹⁾ ETRTO – The European Tyre and Rim Technical Organisation, Brussels

²⁾ ISO – International Organization for Standardization

³⁾ DIN – German Institute for Standardization, Berlin
WdK – German Rubber Manufacturers' Association, Frankfurt/M.

⁴⁾ DOT – Department of Transportation (USA)

⁵⁾ ECE – Economic Commission for Europe (UNO-Institution, Geneva)

⁶⁾ EU – European Union, formerly EEC

SAFETY WARNING!



The instructions given in this databook must be observed to ensure vehicle safety at all times.

This applies especially with respect to tyre inflation pressure recommendations.

Non-compliance with these instructions means risking tyre damage which, if serious enough, may result in a tyre bursting. It is hazards like these that can cause traffic accidents involving vehicle damage and/or serious personal injury.

Introduction, Safety hints	2
Tyre Sidewall Information	4
Service description (Load Index and Speed Index)	6
Units of measurement and definitions of the technical data	7

Passenger Car Tyres

Summer tyres	
Brillantis	8
Bravuris	9
Bravuris 2	10
Winter tyres	
Polaris 2	12
All season tyre	
Quartaris	14
4x4 tyre	
Bravuris 4x4	15
Technical data	16

Van tyres



Vanis	28
SnoVanis	29
Technical data	30

Tyres for caravans and car drawn trailers (special load capacities)	34
Rims	37

Operating instructions

Correct choice of tyre and wheel	41
Winter tyres	41
Fitting the tyre	42
Fitting the wheel to the vehicle	42
Tyre pressure	43
Load capacity and speed	46
Tyre damage	47
Tyre storage	47
Tyre repair	50
Tyre service life	50
Minimum tread depth	51
Guidelines on tyre safety	52

Index	53
Publisher's imprint	55

- ① **225/40 ZR18 92 W**
- 225** Nominal Section width in mm.
 - 40** Nominal aspect ratio
(Tyre height is 40 % of tyre width).
 - R** Symbol for radial tyre.
 - 18** Rim diameter Code (in inches).
 - 92** Load Index "92" = max. load of this tyre is 630 kg
(see table page 6).
 - W** Speed Index, indicating max. speed
W=270 km/h/169 mph (see table page 6).
- ②
- EXTRA LOAD (XL) or „REINFORCED“**
for reinforced tyres,
„**M+S**“ for winter tyres.
-  Snowflake on the mountain (in USA and Canada):
This additional marking on an M+S tyre shows
that the tyre meets prescribed test criteria
and ensures good winter properties.
- ③ **TUBELESS**
- tubeless.
(TUBE TYPE tyres must be mounted with tubes).
- ④ **1509**
- Production code ("15" means 15th week,
"09" means 2009).
- ⑤ **E 4**
- Marking indicating accordance with ECE regulations. The number
after the E in the circle indicates the country of homologation.
 (4=Netherlands)*
- 0222088 Approval number acc. to relevant ECE regulation
- ⑥ **TWI**
- Sign for position of TWI (Tread Wear Indicator).
Cross ribs evenly spaced around the circumference of the tyre in the
longitudinal tread grooves and becoming level with the tread surface when
the remaining tread depth is down to 1.6 mm.
- ⑦ **Made in ...**
- Marking showing the country of origin.

All other information applies to countries outside Europe (esp. USA).

^{*)} This sign may also be ,
if the tyre was homologated in accordance
with the EU guideline 92/23.

Service description

Including Load Index and Speed Index

Load Index (LI)

The Load Index is a numerical code associated with the maximum load a tyre can carry (see also p.46).

LI	kg	LI	kg	LI	kg	LI	kg	LI	kg
50	190	65	290	80	450	95	690	110	1060
51	195	66	300	81	462	96	710	111	1090
52	200	67	307	82	475	97	730	112	1120
53	206	68	315	83	487	98	750	113	1150
54	212	69	325	84	500	99	775	114	1180
55	218	70	335	85	515	100	800	115	1215
56	224	71	345	86	530	101	825	116	1250
57	230	72	355	87	545	102	850	117	1285
58	236	73	365	88	560	103	875	118	1320
59	243	74	375	89	580	104	900	119	1360
60	250	75	387	90	600	105	925	120	1400
61	257	76	400	91	615	106	950	121	1450
62	265	77	412	92	630	107	975	122	1500
63	272	78	425	93	650	108	1000	123	1550
64	280	79	437	94	670	109	1030	124	1600

Speed Index (SI)

The Speed Index indicates the maximum speed at which the tyre can carry a load corresponding to its Load Index.

SI	Max. speed for passenger car tyres	
M	81 mph ¹⁾	130 km/h ¹⁾
P	93 mph	150 km/h
Q	100 mph	160 km/h
R	106 mph	170 km/h
S	112 mph	180 km/h
T	118 mph	190 km/h
H	130 mph	210 km/h
V	150 mph	240 km/h
W	169 mph	270 km/h
Y	187 mph	300 km/h
ZR	over 150 mph	over 240 km/h

SI	Reference speed for commercial vehicle tyres	
K	69 mph	110 km/h
L	75 mph	120 km/h
M	81 mph	130 km/h
N	87 mph	140 km/h
P	93 mph	150 km/h
Q	100 mph	160 km/h
R	106 mph	170 km/h
S	112 mph	180 km/h
T	118 mph	190 km/h
H	130 mph	210 km/h

¹⁾ As a rule only used for special spare tyres if they qualify according to ECE Regulation 30. In accordance with ECE Regulation 64 governing the use of special spare tyres, even these more highly rated tyres may only be used up to a maximum speed of 50 mph (80 km/h).

Units of measurement and definitions of the technical data

The technical data in the tables comply generally with international standards.

All **dimensions** in the tables of this databook are given in millimetres (mm), if not indicated in a different way.

The **rim diameter** is given in inch code. Tyre ranges on new rim types may also be marked in mm.

Construction measurements are theoretical values for the design of the tyre: The **width** is relative to the smooth sidewall, the **outer diameter** to the tread centre.

Maximum measurements are actual **operating measurements** of the inflated tyre (operating pressure) in the unloaded state. They include growth but exclude dynamic distortions.

The **width** is the max. permitted tyre width, including sidewall decorative markings, when the tyre is mounted on the correct rim.

The **outer diameter** is the max. permitted diameter. The max. measurements are binding for **vehicle designers**.

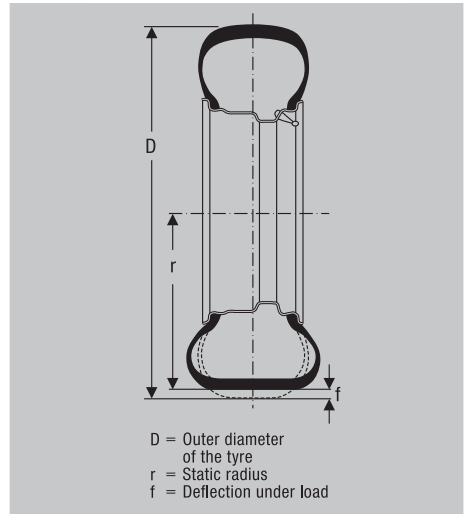
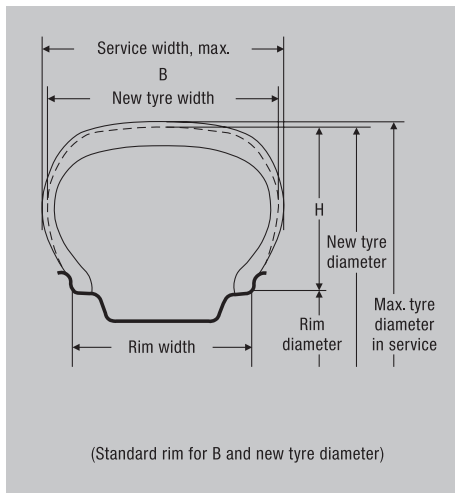

The **static radius** is the distance between the wheel centre and the ground contact patch under max. load at the recommended tyre pressure.

The **rolling circumference** is the distance covered by a point on the circumference when the tyre revolves once at 60 km/h (37 mph).

The **load capacity** in kilograms (kg) is weight in the sense of a mass.

Tyre pressure (inflation pressure) is given in bar as an overpressure (cold tyre), for driving speeds up to 160 km/h (100 mph).

Vehicle designers should bear in mind the **maximum values** for tyre outer diameter and width when planning the **wheel space of a vehicle**, if all standard approved tyres are to fit without any restrictions. Should this by way of exception not be possible, the safety risk must be eliminated by taking appropriate measures.

High performance at low cost

The Brillantis – a summer tyre offering a long service life, comfort and good grip, whatever the conditions.



- Long service life through flat belt contour.
- Sturdy shoulder lugs minimise uneven tread wear.
- New contour shape enhances driving stability and comfort.

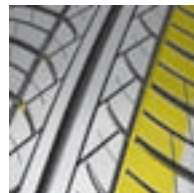

- Outstanding longitudinal and lateral water dispersion through longitudinal shoulder grooves.
- Central groove reduces the risk of aquaplaning.
- Increased mileage performance through optimised tread compound.

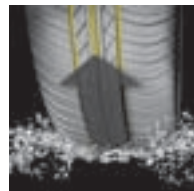

- Efficient transmission of forces on wet and dry roads, thanks to high tread rigidity.
- Sipes in the tread pattern reduce noise levels.
- Sturdy tread lugs increase tyre life.



Size range

80 series	
135/80 R 13	70 T
145/80 R 13	75 T
155/80 R 13	79 T
165/80 R 13	83 T +
165/80 R 14	85 T
175/80 R 14	88 T
	88 H
70 series	
145/70 R 13	71 T
155/70 R 13	75 T
165/70 R 13	79 T
165/70 R 13 XL	83 T
175/70 R 13	82 T
	82 H

70 series	
185/70 R 13	86 T
165/70 R 14	81 T
165/70 R 14 XL	85 T
175/70 R 14	84 T
	84 H
185/70 R 14	88 T
	88 H
195/70 R 14	91 T
65 series	
155/65 R 13	73 T
165/65 R 13	77 T
175/65 R 13	80 T
155/65 R 14	75 T
165/65 R 14	79 T

65 series	
175/65 R 14	82 T
175/65 R 14 XL	86 T
185/65 R 14	86 T
185/65 R 15	88 T
195/65 R 15	91 T
60 series	
185/60 R 13	80 H
165/60 R 14	75 H
175/60 R 14	79 H
185/60 R 14	82 T

+ Tread OR57 Brillantis

See cover foldout for footnotes.

Sunny prices for demanding drivers

The Bravuris – for good grip during acceleration, perfect water dispersion and superior control, whatever the conditions.



- Optimised tread pattern with flat belt contour.
- Even pressure distribution reduces tyre wear.
- Increased driving stability and tyre life through tread ribs.

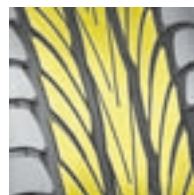

- Precise steering response, thanks to sturdy shoulder lugs.
- Circumferential central rib ensures optimum straight-line stability.
- Rugged tread lugs increase mileage performance.

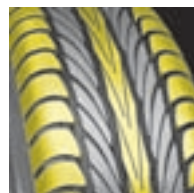

- Lateral grooves reduce the risk of aquaplaning.
- Good grip on wet and dry roads thanks to optimised tread compound.
- Enhanced comfort and minimised driving noise through offset tread lugs.



Size range

65 series	
175/65 R 14	82 H
185/65 R 14	86 H
195/65 R 14	89 H
185/65 R 15	88 H

60 series	
185/60 R 14	82 H <input type="checkbox"/>
195/60 R 14	86 H <input type="checkbox"/>
185/60 R 15	84 H
215/60 R 15	94 H <input type="checkbox"/>
225/60 R 16	98 W (ZR)

55 series		
185/55 R 14	80 H	FR

See cover foldout for footnotes.

The economical high performer

The new Bravuris 2 – so much driving pleasure for so little money! Barum's fastest all-rounder for long-lasting fun.



- Innovative asymmetrical tread pattern.
- Higher mileage performance – through computer-optimised contour and the latest silica compound.
- Even pressure distribution for reduced wear.



- Large tread lugs on the tyre outer side ensure handling stability and safe braking on dry roads.
- Siped ribs provide optimum steering precision – even at high speed.
- Max. traction and outstanding braking power through sturdy lugs.



- Large number of lugs on the tyre inner side reduce the risk of aquaplaning and provide safety when braking in the wet.
- Wide grooves disperse water quickly and efficiently.
- New silica compound means best grip on wet roads.



Size range

65 series	
195/65 R 15	91 H 91 V
205/65 R 15	94 H 94 V →
215/65 R 15	96 H

60 series	
195/60 R 15	88 H → 88 V →
205/60 R 15	91 H → 91 V →
215/60 R 15	94 H →
225/60 R 15	96 V
205/60 R 16	92 H → 92 V →
215/60 R 16 XL	99 H
235/60 R 16	100 W

55 series	
185/55 R 14	80 H →
185/55 R 15	82 H 82 V
195/55 R 15	85 H → 85 V →
205/55 R 15	88 V
205/55 R 16	91 H 91 V 91 W (ZR)
215/55 R 16	93 H 93 W (ZR)
215/55 R 16 XL	97 H 97 W (ZR)
225/55 R 16	95 V 95 W (ZR)
215/55 R 17	94 W (ZR)
225/55 R 17 XL	101 W (ZR)

50 series	
195/50 R 15	82 H → 82 V →
205/50 R 15	86 V
205/50 R 16	87 W (ZR)
225/50 R 16	92 W (ZR)
205/50 R 17 XL	93 W (ZR) FR
215/50 R 17	91 W (ZR) FR
225/50 R 17 XL	98 W (ZR) FR

45 series	
195/45 R 15	78 V FR
195/45 R 16	80 V FR
205/45 R 16	83 V FR 83 W (ZR) FR
205/45 R 17 XL	88 W (ZR) FR
215/45 R 17 XL	91 W (ZR) FR
225/45 R 17	91 W (ZR) FR
225/45 R 17 XL	94 W (ZR) FR
235/45 R 17	94 W (ZR) FR
245/45 R 17	95 W (ZR) FR
225/45 R 18	91 Y (ZR) FR
245/45 R 18	96 W (ZR) FR
255/45 R 18 XL	103 Y (ZR) FR

40 series	
215/40 R 16 XL	86 W (ZR) FR
205/40 R 17 XL	84 W (ZR) FR
215/40 R 17 XL	87 W (ZR) FR
235/40 R 17	90 W (ZR) FR
245/40 R 17	91 W (ZR) FR
255/40 R 17	94 W (ZR) FR
225/40 R 18 XL	92 W (ZR) FR
235/40 R 18 XL	95 W (ZR) FR
245/40 R 18 XL	97 Y (ZR) FR
255/40 R 19 XL	100 Y (ZR) FR

35 series	
255/35 R 18 XL	94 W (ZR) FR
265/35 R 18	93 W (ZR) FR
235/35 R 19 XL	91 Y (ZR) FR
255/35 R 19 XL	96 Y (ZR) FR
245/35 R 20 XL	95 Y (ZR) FR
255/35 R 20 XL	97 Y (ZR) FR

See cover foldout for footnotes.

Low-cost winter driving fun. A safe bet!

Polaris 2 – the all-rounder for superior road handling at all times. This winter tyre provides good grip in snow and slush, on ice and in the wet. Consistently – and at an optimum price/performance ratio. Approved for speeds up to 240 km/h (150 mph).



Sipes

- Combined stepped and wave-shaped sipes.
- Dig deep into the snow.
- Ensure good lateral guidance.

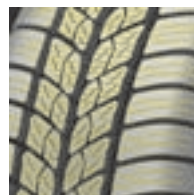

Tread

- With supple silica compound.
- Grips very well on wet roads too.
- Disperses water and slush very efficiently.



Contour

- Designed for comfortable running.
- Stabilises lateral movement.
- Ensures low wear.



As V version up to 240 km/h (150 mph)

Size range

80 series	
135/80 R 13	70 T
145/80 R 13	75 T
155/80 R 13	79 T
165/80 R 13	83 T
165/80 R 14	85 T
175/80 R 14	88 T
70 series	
145/70 R 13	71 T
155/70 R 13	75 T
165/70 R 13	79 T
165/70 R 13 XL	83 T
175/70 R 13	82 T
165/70 R 14	81 T
175/70 R 14	84 T
185/70 R 14	88 T

65 series	
155/65 R 13	73 T
175/65 R 13	80 T
155/65 R 14	75 T
165/65 R 14	79 T
175/65 R 14	82 T
175/65 R 14 XL	86 T
185/65 R 14	86 T
195/65 R 14	89 T
185/65 R 15	88 T
195/65 R 15	91 T
	91 H
195/65 R 15 XL	95 T
205/65 R 15	94 T
	94 H
215/65 R 15	96 H
215/65 R 16	98 H

60 series	
185/60 R 14	82 T
185/60 R 15	84 T
185/60 R 15 XL	88 T
195/60 R 15	88 T
	88 H
205/60 R 15	91 T
	91 H
205/60 R 16	92 H
215/60 R 16 XL	99 H
225/60 R 16 XL	102 H

55 series		
185/55 R 14	80 T	FR
185/55 R 15	82 T	
195/55 R 15	85 H	
205/55 R 16	91 T	FR
	91 H	FR
205/55 R 16 XL	94 H	
	94 V	
215/55 R 16	93 H	
215/55 R 16 XL	97 H	
225/55 R 16	95 H	FR
225/55 R 16 XL	99 H	FR
225/55 R 17 XL	101 V	

50 series		
195/50 R 15	82 T	FR
	82 H	FR
205/50 R 16	87 H	
205/50 R 17 XL	93 H	FR
45 series		
225/45 R 17	91 H	FR
225/45 R 17 XL	94 V	FR

See cover foldout for footnotes.

The new Barum all-season tyre. Well-balanced all-season performance characteristics, high mileage potential.



Outstanding traction on snow and short braking distances on ice

- Good grip in snow and ice by many gripping edges (sipes and recess structure)
- “Snowflake on the Mountain” symbol indicates “suitability for use in wintry road conditions”
- Winter TWI at 4 mm indicates the limit of winter suitability



Good aquaplaning characteristics and short braking distances

- Directionally orientated tread pattern with wide circumferential grooves and many lateral channels
- Shallow sipes mean optimum water dispersion when braking
- Part-silica compound with high road grip



Precise steering response and short braking distances on dry roads

- Straight ribs in the central section
- Large shoulder blocks provide high stiffness



Size range

70 series	
155/70 R 13	75 T
165/70 R 13	79 T
175/70 R 13	82 T
165/70 R 14	81 T
175/70 R 14	84 T

65 series	
165/65 R 14	79 T
175/65 R 14	82 T
185/65 R 14	86 T
185/65 R 15	88 T
	88 H
195/65 R 15	91 T
	91 H

60 series	
185/60 R 14	82 T
	82 H
195/60 R 15	88 H
205/60 R 15	91 H
55 series	
205/55 R 16	91 H
50 series	
195/50 R 15	82 H

See cover foldout for footnotes.

The ideal tyre for driving on the road and in light off-road conditions.



High mileage performance, long service life

- Extra-flat tyre contour
- Optimised tread blocks for even stiffness
- Wear-resistant tread compound

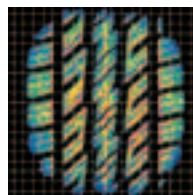

High safety and short braking distance on wet and dry roads

- Large sturdy tread blocks in the shoulder
- Latest tread compound for best grip in the wet



Comfortable ride, low tyre noise

- Different numbers of tread blocks in the shoulder and central section
- Optimised sipe arrangement



Size range

80 series		
205/80 R 16 XL	104 T	→
75 series		
235/75 R 15 XL	109 T	
245/75 R 15 C	109 / 107 T	→
185/75 R 16	92 T	→
225/75 R 16	104 T	FR →

70 series		
205/70 R 15	96 T	→
265/70 R 15	112 H	→
215/70 R 16	100 H	
225/70 R 16	102 H	→
235/70 R 16	106 H	
245/70 R 16	107 H	
265/70 R 16	112 H	

65 series		
215/65 R 16	98 H	→
255/65 R 16	109 H	→
235/65 R 17 XL	108 V	FR

60 series		
235/60 R 16	100 H	→
235/60 R 18 XL	107 V	FR
55 series		
255/55 R 18 XL	109 V	FR
Flotation sizes		
LT 31 x 10.50 R 15	109 S	FR

See cover foldout for footnotes.

Technical data

Size	Tyre		Permitted rims ¹⁾ (width code)	Tyre dimensions Max. standard value in operation ²⁾		Radius stat. +/- 2% (mm)	Rolling circumference ³⁾ +1.5% -2.5% (mm)
	Load Index	Max. Load capacity (kg)		Width (mm)	Outer-Ø (mm)		
80 series***)							
135/80 R 13	70	335	3 ½ J	138	554	249	1665
			4 J	143			
			4 ½ J	149			
145/80 R 13	75	387	3 ½ J	146	572	255	1715
			4 J	151			
			4 ½ J	156			
155/80 R 13	79	437	5 J	161	588	262	1765
			4 J	158			
			4 ½ J	163			
165/80 R 13	83	487	5 J	168	604	268	1810
			4 J	167			
			4 ½ J	172			
165/80 R 14	85	515	5 ½ J	177	631	281	1890
			4 J	167			
			4 ½ J	172			
175/80 R 14	88	560	5 ½ J	182	648	287	1940
			4 J	179			
			5 J	184			
205/80 R 16 XL	104	900	5 ½ J	189	748	331	2239
			6 J	194			
			6 ½ J	206			
75 series							
235/75 R 15 XL	109	1030	5 J	206	747	328	2236
			6 J	211			
			6 ½ J	216			
			7 J	219			
			7 ½ J	224			
185/75 R 16	92	630	8 J	259	***	***	****
			4 ½ J	186			
			5 J	191			
			5 ½ J	197			
225/75 R 16	104	900	6 J	202	758	335	2269
			6 J	232			
			6 ½ J	237			
			7 J	242			
			7 ½ J	247			

See cover foldout for footnotes.

Technical data

Size	Tyre		Permitted rims ¹⁾ (width code)	Tyre dimensions Max. standard value in operation ²⁾		Radius stat. +/- 2% (mm)	Rolling circumference ³⁾ +1.5% -2.5% (mm)
	Load Index	Max. Load capacity (kg)		Width (mm)	Outer-Ø (mm)		
70 series							
145/70 R 13	71	345	3 ½ J	146			
			4 J	151			
			4 ½ J	156	542	245	1630
			5 J	161			
155/70 R 13	75	387	4 J	158			
			4 ½ J	163	556	250	1670
			5 J	168			
165/70 R 13	79	437	4 J	167			
165/70 R 13 XL	83	487	4 ½ J	172			
			5 J	177	572	256	1715
			5 ½ J	182			
175/70 R 13	82	475	4 ½ J	179			
			5 J	184	586	261	1755
			5 ½ J	189			
			6 J	194			
185/70 R 13	86	530	4 ½ J	187			
			5 J	192			
			5 ½ J	197	600	266	1800
			6 J	202			
165/70 R 14	81	462	4 J	167			
165/70 R 14 XL	85	515	4 ½ J	172			
			5 J	177	598	268	1795
			5 ½ J	182			
175/70 R 14	84	500	4 ½ J	179			
			5 J	184	612	274	1835
			5 ½ J	189			
			6 J	194			
185/70 R 14	88	560	4 ½ J	187			
			5 J	192			
			5 ½ J	197	626	279	1880
			6 J	202			
195/70 R 14	91	615	5 J	199			
			5 ½ J	204			
			6 J	209	640	285	1920
			6 ½ J	214			
195/70 R 15 Rf.	97	730	5 J	199			
			5 ½ J	204			
			6 J	209	665	297	2000
			6 ½ J	214			
205/70 R 15	96	710	5 J	207			
			5 ½ J	212			
			6 J	217	681	303	2040
			6 ½ J	222			
			7 J	227			

See cover foldout for footnotes.

Technical data

Size	Tyre		Permitted rims ¹⁾	Tyre dimensions		Radius	Rolling circum- ference ³⁾
	Load Index	Max. Load capacity		Max. standard value in operation ²⁾			
	LI	(kg)	(width code)	Width (mm)	Outer-Ø (mm)		+1.5 % -2.5 % (mm)
70 series							
265/70 R 15	112	1120	7 J	272			
			7 ½ J	277			
			8 J	282	767	336	2297
			8 ½ J	287			
215/70 R 16	100	800	9 J	292			
			5 ½ J	220			
			6 J	225			
			6 ½ J	230	720	321	2159
225/70 R 16	102	850	7 J	235			
			6 J	232			
			6 ½ J	237	734	326	2202
			7 ½ J	247			
235/70 R 16	106	950	6 J	240			
			6 ½ J	245			
			7 J	250	750	332	2245
			7 ½ J	255			
245/70 R 16	107	975	8 J	260			
			6 ½ J	253			
			7 J	258	764	337	2287
			7 ½ J	263			
265/70 R 16	112	1120	8 J	268			
			7 J	273			
			7 ½ J	278			
			8 J	283	792	348	2373
			8 ½ J	288			
			9 J	293			

See cover foldout for footnotes.

Technical data

Size	Tyre		Permitted rims ¹⁾ (width code)	Tyre dimensions Max. standard value in operation ²⁾		Radius stat. +/- 2% (mm)	Rolling circum- ference ³⁾ +1.5 % -2.5 % (mm)
	Load Index	Max. Load capacity (kg)		Width (mm)	Outer-Ø (mm)		
65 series							
155/65 R 13	73	365	4 ½ J	163	540	244	1625
			5 J	168			
			5 ½ J	173			
165/65 R 13	77	412	4 ½ J	172	552	248	1660
			5 J	177			
			5 ½ J	182			
175/65 R 13	80	450	6 J	187	568	254	1700
			5 J	184			
			5 ½ J	189			
155/65 R 14	75	387	6 J	194	566	257	1700
			4 ½ J	163			
			5 J	168			
165/65 R 14	79	437	5 ½ J	173	578	261	1740
			4 ½ J	172			
			6 J	187			
175/65 R 14	82	475	5 J	184	594	267	1780
175/65 R 14 XL	86	530	5 ½ J	189			
			6 J	194			
185/65 R 14	86	530	6 J	202	606	272	1820
			5 J	192			
			6 ½ J	207			
195/65 R 14	89	580	7 J	219	620	277	1860
			5 ½ J	204			
			6 J	209			
185/65 R 15	88	560	6 ½ J	207	631	284	1895
			5 J	192			
			6 J	202			
195/65 R 15	91	615	5 ½ J	204			
195/65 R 15 XL	95	690	6 J	209	645	290	1935
			6 ½ J	214			
			7 J	219			
205/65 R 15	94	670	5 ½ J	212			
205/65 R 15 Rf.	99	775	6 J	217	657	294	1975
			6 ½ J	222			
			7 J	227			
			7 ½ J	232			

See cover foldout for footnotes.

Technical data

Size	Tyre		Permitted rims ¹⁾ (width code)	Tyre dimensions Max. standard value in operation ²⁾		Radius stat. +/- 2% (mm)	Rolling circumference ³⁾ +1.5% -2.5% (mm)
	Load Index	Max. Load capacity (kg)		Width (mm)	Outer-Ø (mm)		
65 series							
215/65 R 15	96	710	6 J	225	673	300	2015
			6 ½ J	230			
			7 J	235			
			7 ½ J	240			
215/65 R 16	98	750	6 J	225	698	312	2090
			6 ½ J	230			
			7 J	235			
			7 ½ J	240			
255/65 R 16	109	1030	7 J	265	752	332	2251
			7 ½ J	270			
			8 J	275			
			8 ½ J	280			
			9 J	285			
235/65 R 17 XL	108	1000	6 ½ J	245	750	335	2251
			7 J	250			
			7 ½ J	255			
			8 J	260			
			8 ½ J	265			
60 series							
185/60 R 13	80	450	5 J	192	560	252	1685
			5 ½ J	197			
			6 J	202			
			6 ½ J	207			
165/60 R 14	75	387	4 ½ J	172	562	255	1690
			5 J	177			
			5 ½ J	182			
			6 J	187			
175/60 R 14	79	437	5 J	184	574	260	1725
			5 ½ J	189			
			6 J	194			
185/60 R 14	82	475	5 J	192	586	265	1765
			5 ½ J	197			
			6 J	202			
			6 ½ J	207			
195/60 R 14	86	530	5 ½ J	204	600	269	1800
			6 J	209			
			6 ½ J	214			
			7 J	219			
185/60 R 15	84	500	5 J	192	611	277	1840
185/60 R 15 XL	88	560	5 ½ J	197			
			6 J	202			
			6 ½ J	207			

See cover foldout for footnotes.

Technical data

Size	Tyre		Permitted rims ¹⁾ (width code)	Tyre dimensions Max. standard value in operation ²⁾		Radius stat. +/- 2% (mm)	Rolling circum- ference ³⁾ +1.5 % -2.5 % (mm)
	Load Index	Max. Load capacity (kg)		Width (mm)	Outer-Ø (mm)		
60 series							
195/60 R 15	88	560	5 ½ J	204	625	282	1875
			6 J	209			
			6 ½ J	214			
			7 J	219			
205/60 R 15	91	615	5 ½ J	212	637	286	1910
			6 J	217			
			6 ½ J	222			
			7 J	227			
215/60 R 15	94	670	6 J	225	649	291	1950
			6 ½ J	230			
			7 J	235			
			7 ½ J	240			
225/60 R 15	96	710	6 J	232	661	296	1985
			6 ½ J	237			
			7 J	242			
			7 ½ J	247			
205/60 R 16	92	630	5 ½ J	212	662	299	1990
			6 J	217			
			6 ½ J	222			
			7 J	227			
215/60 R 16 XL	99	775	6 J	225	674	304	2025
			6 ½ J	230			
			7 J	235			
			7 ½ J	240			
225/60 R 16	98	750	6 J	232	686	308	2060
225/60 R 16 XL	102	850	6 ½ J	237			
			7 J	242			
			7 ½ J	247			
235/60 R 16	100	800	8 J	252	700	313	2100
			6 ½ J	245			
			7 J	250			
			7 ½ J	255			
235/60 R 18 XL	107	975	8 J	260	751	338	2254
			8 ½ J	265			
			6 ½ J	245			
			7 J	250			
			7 ½ J	255			
			8 J	260			
			8 ½ J	265			

See cover foldout for footnotes.

Technical data

Size	Tyre		Permitted rims ¹⁾ (width code)	Tyre dimensions Max. standard value in operation ²⁾		Radius stat. +/- 2% (mm)	Rolling circum- ference ³⁾ +1.5% -2.5% (mm)
	Load Index	Max. Load capacity (kg)		Width (mm)	Outer-Ø (mm)		
55 series							
185/55 R 14	80	450	5 J	192			
			5 ½ J	197			
			6 J	202	568	258	1710
			6 ½ J	207			
185/55 R 15	82	475	5 J	192			
			5 ½ J	197			
			6 J	202	593	270	1785
			6 ½ J	207			
195/55 R 15	85	515	5 ½ J	204			
			6 J	209	603	282	1815
			6 ½ J	214			
			7 J	219			
205/55 R 15	88	560	5 ½ J	213			
			6 J	218			
			6 ½ J	223	617	279	1850
			7 J	228			
			7 ½ J	233			
205/55 R 16	91	615	5 ½ J	213			
205/55 R 16 XL	94	670	6 J	218			
			6 ½ J	223	642	291	1930
			7 J	228			
			7 ½ J	233			
215/55 R 16	93	650	6 J	225			
215/55 R 16 XL	97	730	6 ½ J	230			
			7 J	235	652	295	1960
			7 ½ J	240			
225/55 R 16	95	690	6 J	232			
225/55 R 16 XL	99	775	6 ½ J	237			
			7 J	242	664	300	1995
			7 ½ J	247			
			8 J	252			
215/55 R 17	94	670	6 J	225			
			6 ½ J	230			
			7 J	235	678	308	2035
			7 ½ J	240			
225/55 R 17	97	730	6 J	232			
225/55 R 17 XL	101	825	6 ½ J	237			
			7 J	242	690	313	2075
			7 ½ J	247			
			8 J	252			
255/55 R 18 XL	109	1030	7 J	266			
			7 ½ J	271			
			8 J	276	749	338	2248
			8 ½ J	281			
			9 J	286			

Technical data

Size	Tyre		Permitted rims ¹⁾	Tyre dimensions		Radius	Rolling circum- ference ³⁾
	Load Index	Max. Load capacity		Max. standard value in operation ²⁾			
	LI	(kg)	(width code)	Width (mm)	Outer-Ø (mm)	stat. +/- 2% (mm)	+1.5% -2.5% (mm)
50 series							
195/50 R 15	82	475	5 ½ J	204			
			6 J	209	585	267	1760
			6 ½ J	214			
			7 J	219			
205/50 R 15	86	530	5 ½ J	213			
			6 J	218			
			6 ½ J	223	595	271	1790
			7 J	228			
			7 ½ J	233			
205/50 R 16	87	545	5 ½ J	213			
			6 J	218			
			6 ½ J	223	620	283	1865
			7 J	228			
			7 ½ J	233			
225/50 R 16	92	630	6 J	232			
			6 ½ J	237			
			7 J	242	642	291	1930
			7 ½ J	247			
205/50 R 17 XL	93	650	5 ½ J	213			
			6 J	218			
			6 ½ J	223	646	296	1945
			7 J	228			
			7 ½ J	233			
215/50 R 17	91	615	6 J	225			
			6 ½ J	230			
			7 J	235	656	300	1975
			7 ½ J	240			
225/50 R 17	94	670	6 J	232			
225/50 R 17 XL	98	750	6 ½ J	237			
			7 J	242	668	304	2005
			7 ½ J	247			
			8 J	252			

See cover foldout for footnotes.

Technical data

Size	Tyre		Permitted rims ¹⁾ (width code)	Tyre dimensions Max. standard value in operation ²⁾		Radius stat. +/- 2% (mm)	Rolling circum- ference ³⁾ +1.5 % -2.5 % (mm)
	Load Index	Max. Load capacity (kg)		Width (mm)	Outer-Ø (mm)		
45 series							
195/45 R 15	78	425	6 J	198	565	259	1700
			6 1/2 J	203			
			7 J	208			
			7 1/2 J	213			
195/45 R 16	80	450	6 J	198	590	272	1775
			6 1/2 J	203			
			7 J	208			
			7 1/2 J	213			
205/45 R 16	83	487	6 1/2 J	209	598	275	1800
			7 J	214			
			7 1/2 J	219			
205/45 R 17 XL	88	560	6 1/2 J	209	624	288	1879
			7 J	214			
			7 1/2 J	219			
215/45 R 17 XL	91	615	7 J	222	634	300	1910
			7 1/2 J	227			
			8 J	232			
225/45 R 17	91	615	7 J	229	642	295	1930
225/45 R 17 XL	94	670	7 1/2 J	234			
			8 J	239			
235/45 R 17	94	670	8 1/2 J	244	652	299	1965
			7 1/2 J	240			
			8 J	245			
245/45 R 17	95	710	8 1/2 J	250	660	302	1990
			9 J	255			
			7 1/2 J	248			
			8 J	253			
225/45 R 18	91	615	8 1/2 J	258	667	307	2010
			9 J	263			
			7 J	229			
			7 1/2 J	234			
245/45 R 18	96	710	8 J	239	685	314	2065
			8 1/2 J	244			
			7 1/2 J	248			
			8 J	253			
255/45 R 18 XL	103	875	9 J	263	697	318	2095
			8 J	260			
			8 1/2 J	265			
			9 1/2 J	275			

See cover foldout for footnotes.

Technical data

Size	Tyre		Permitted rims ¹⁾ (width code)	Tyre dimensions Max. standard value in operation ²⁾		Radius stat. +/- 2% (mm)	Rolling circum- ference ³⁾ +1.5 % -2.5 % (mm)
	Load Index	Max. Load capacity (kg)		Width (mm)	Outer-Ø (mm)		
40 series							
215/40 R 16 XL	86	530	7 J	222	584	270	1765
			7 1/2 J	227			
			8 J	232			
			8 1/2 J	237			
205/40 R 17 XL	84	500	7 J	215	602	280	1820
			7 1/2 J	220			
			8 J	225			
215/40 R 17	83	487	7 J	222	610	283	1840
215/40 R 17 XL	87	545	7 1/2 J	227			
			8 J	232			
235/40 R 17	90	600	8 1/2 J	246	628	289	1890
			8 1/2 J	251			
			9 J	256			
			9 1/2 J	261			
245/40 R 17	91	615	8 J	253	636	292	1915
			8 1/2 J	258			
			9 J	263			
			9 1/2 J	268			
255/40 R 17	94	670	8 1/2 J	265	644	296	1940
			9 J	270			
			9 1/2 J	275			
			10 J	280			
225/40 R 18 XL	92	630	7 1/2 J	234	645	299	1945
			8 J	239			
			8 1/2 J	244			
			9 J	249			
235/40 R 18	91	615	8 J	246	653	302	1965
235/40 R 18 XL	95	690	8 1/2 J	251			
			9 J	256			
245/40 R 18 XL	97	730	9 1/2 J	261	661	305	1960
			8 J	253			
			8 1/2 J	258			
			9 J	263			
255/40 R 19 XL	100	800	9 1/2 J	268	695	321	2095
			8 1/2 J	265			
			9 J	270			
			9 1/2 J	275			
			10 J	280			

See cover foldout for footnotes.

Technical data

Size	Tyre		Permitted rims ¹⁾ (width code)	Tyre dimensions Max. standard value in operation ²⁾		Radius stat. +/- 2% (mm)	Rolling circumference ³⁾ + 1.5% - 2.5% (mm)
	Load Index	Max. Load capacity (kg)		Width (mm)	Outer-Ø (mm)		
35 series							
255/35 R 18 XL	94	670	8 ½ J	265	643	295	1935
			9 J	270			
			9 ½ J	275			
			10 J	280			
			9 J	277			
			9 ½ J	282			
265/35 R 18	93	650	10 J	287	651	301	1960
			10 ½ J	292			
			8 J	246			
235/35 R 19 XL	91	615	8 ½ J	251	653	305	1975
			9 J	256			
			9 ½ J	261			
255/35 R 19 XL	96	710	8 ½ J	265	669	311	2015
			9 J	270			
			9 ½ J	275			
			10 J	280			
			8 J	253			
			8 ½ J	258			
245/35 R 20 XL	95	690	9 J	263	686	321	2075
			9 ½ J	268			
			8 ½ J	265			
255/35 R 20 XL	97	730	9 J	270	694	323	2090
			9 ½ J	275			
			10 J	280			

LT-flotation sizes 4x4										
LT 31 x 10.50 R 15	109	1030	7 J	263						
			7 ½ J	268						
			8 J	273						
			8 ½ J	278						
			9 J	283						
			2.0	2.25	2.5	2.75	3.0	3.25	3.5	
Continued			1400	1510	1600	1735	1845	1960	2060	Q 160
LT 31 x 10.50 R 15										S 180

See cover foldout for footnotes.

**A sound deal –
the economical all-rounder**

The Vanis – good handling and excellent driving performance in the wet are this tyre's outstanding features.



- Good traction at lower loads, thanks to supple sipes.
- Firm grip under dynamic loads through fine angled grooves.
- Reliable grip in all directions, thanks to multi-edged lugged ribs.
- Even wear through flat belt contour.
- Sturdy tread lug structure ensures a long tyre life.
- Tread lugs vary in length, thereby reducing noise levels.
- Wide, circumferential grooves channel water out of the tread.
- Optimised tread pattern reduces the risk of aquaplaning.
- New tread compound ensures high mileage performance.

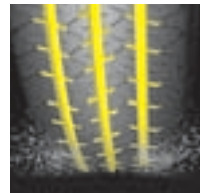
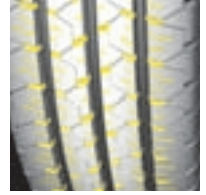

Size range

14 Inch			
185	R 14 C	8 PR	102/100 Q
195	R 14 C	8 PR	106/104 Q
165/70	R 14 C	6 PR	89/87 R
195/70	R 14 C	8 PR	101/99 R → (104 N)
175/65	R 14 C	6 PR	90/88 T
15 Inch			
185	R 15 C	8 PR	103/102 R
195/70	R 15 C	8 PR	104/102 R
205/70	R 15 C	8 PR	106/104 R
225/70	R 15 C	8 PR	112/110 R
205/65	R 15 C	6 PR	102/100 T
205/65	R 15 Rf.		99 T

16 Inch			
175/75	R 16 C	8 PR	101/99 R
185/75	R 16 C	8 PR	104/102 R
195/75	R 16 C	8 PR	107/105 R
205/75	R 16 C	8 PR	110/108 R
215/75	R 16 C	8 PR	113/111 R
		10 PR	116/114 R
225/75	R 16 C	10 PR	121/120 R

16 Inch			
195/65	R 16 C	8 PR	104/102 T (100 T)
205/65	R 16 C	8 PR	107/105 T (103 T)
215/65	R 16 C	8 PR	109/107 R (106 T)
225/65	R 16 C	8 PR	112/110 R
195/60	R 16 C	6 PR	99/97 H

See cover foldout for footnotes.

**Very safe driving.
Very good savings.**

The SnoVanis combines safe driving characteristics, high mileage performance and low price. Plus optimum ground contact. A tyre for MPVs and light vans – even in the toughest applications on snow-covered roads.



Grooves and sipes

- Perfect traction thanks to high number of sipes.
- Lateral grooves disperse water efficiently.
- For more fun at the wheel while keeping a safe grip on the road.

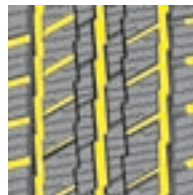

Tread ribs

- Offset arrangement of central ribs.
- Provide counter-support.
- Increase driving stability.

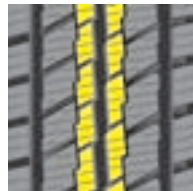

Contour

- Flat contour through flat tyre belt.
- Reduces deformation and slip.
- Minimises wear – for a long service life.



Size range

14 Inch			
185	R 14 C	8 PR	102/100 Q
195	R 14 C	8 PR	106/104 Q
165/70	R 14 C	6 PR	89/87 R
175/65	R 14 C	6 PR	90/88 T

15 Inch			
195/70	R 15 C	8 PR	104/102 R
195/70	R 15 Rf.		97 T
205/70	R 15 C	8 PR	106/104 R
225/70	R 15 C	8 PR	112/110 R
205/65	R 15 C	6 PR	102/100 T
205/65	R 15 Rf.		99 T

16 Inch			
195/75	R 16 C	8 PR	107/105 R
205/75	R 16 C	8 PR	110/108 R
195/65	R 16 C	8 PR	104/102 T (100 T)
205/65	R 16 C	8 PR	107/105 T (103 T)
215/65	R 16 C	8 PR	109/107 R (106 T)
225/65	R 16 C	8 PR	112/110 R
195/60	R 16 C	6 PR	99/97 T

See cover foldout for footnotes.

Technical data van tyres

Size	Tyre		Rim ⁵⁾	Tyre dimensions (mm)						Radius stat. +/- 2%	Rolling circum- ference +1.5 % -2.5%
	PR	Service description ⁴⁾		Max. standard value in operation ⁶⁾				new			
				Width		Outer-Ø		Width	Outer- Ø		
Stand- ard	Spe- cial	Stand- ard	Spe- cial	Width	Outer- Ø	Width	Outer- Ø				
14 Inch											
175 R 14 C	8	99/98 Q	4 ½ J	178	–	–	–	172	–	289	1920
			5 J	183	–	642	–	178	634		
			5 ½ J	188	–	–	183	–			
185 R 14 C	8	102/100 Q	5 J	189	198	–	–	183	–	296	1970
			5 ½ J	194	203	659	665	188	650		
			6 J	199	208	–	–	193	–		
195 R 14 C	8	106/104 Q	5 J	199	209	–	–	193	–	302	2018
			5 ½ J	204	214	675	682	198	666		
			6 J	209	219	–	–	203	–		
165/70 R 14 C	6	89/87 R	4 ½ J	172	–	–	–	165	–	271	1782
			5 J	177	–	598	602	170	588		
195/70 R 14 C	8	101/99 R (104 N)	5 J	199	–	–	–	191	–	288	1909
			5 ½ J	204	–	–	–	196	630		
			6 J	209	640	646	201	–			
175/65 R 14 C	6	90/88 T	5 J	186	594	598	–	177	584	267	1780
			5 ½ J	191	–	–	182	–			
15 Inch											
185 R 15 C	6	100/98 Q	5 J	189	198	–	–	183	–	308	2042
	8	103/102 R	5 ½ J	194	203	683	689	188	674		
			6 J	199	208	–	–	193	–		
195/70 R 15 C	8	104/102 R	5 J	199	–	–	–	191	–	300	1985
			5 ½ J	204	–	–	–	196	–		
			6 J	209	665	671	201	655			
205/70 R 15 C	8	106/104 R	5 ½ J	212	–	–	–	204	–	306	2027
			6 J	217	681	687	209	669			
			6 ½ J	222	–	–	214	–			
225/70 R 15 C	8	112/110 R	6 J	232	–	–	–	223	–	317	2112
			6 ½ J	237	709	715	228	697			
			7 J	242	–	–	233	–			
205/65 R 15 C	6	102/100 T	5 ½ J	212	–	–	–	204	–	297	1960
			6 J	217	657	663	209	647			
			6 ½ J	222	–	–	214	–			

See cover foldout for footnotes.

Technical data van tyres

PR	Load Index LI	Wheel position ⁷⁾	Load capacity (kg) per axle at a tyre pressure (bar)								Speed Index and reference speed (km/h)
			3.0	3.25	3.5	3.75	4.0	4.25	4.5	4.75	
8	99	E	1120	1195	1270	1340	1410	1480	1550		Q 160
	98	Zw	2170	2310	2450	2590	2730	2865	3000		
8	102	E	1230	1310	1390	1470	1545	1625	1700		Q 160
	100	Zw	2315	2465	2620	2765	2915	3060	3200		
8	106	E	1375	1465	1555	1645	1730	1815	1900		Q 160
	104	Zw	2605	2775	2945	3110	3275	3440	3600		
6	89	E	970	1035	1100	1160					R 170
	87	Zw	1825	1945	2065	2180					
8	101	E	1140	1220	1290	1365	1440	1510	1580	1650	R 170
	99	Zw	2145	2290	2430	2565	2700	2835	2970	3100	
	104	E	1150	1225	1300	1375	1450	1520	1590	1660	
6	90	E	1005	1070	1135	1200					T 190
	88	Zw	1875	2000	2120	2240					
6	100	E	1340	1425	1515	1600					Q 160
	98	Zw	2510	2675	2840	3000					
8	103	E	1265	1350	1435	1515	1595	1675	1750		R 170
	102	Zw	2460	2620	2780	2940	3095	3250	3400		
8	104	E	1300	1385	1470	1555	1640	1720	1800		R 170
	102	Zw	2460	2620	2780	2940	3095	3250	3400		
8	106	E	1375	1465	1555	1640	1730	1815	1900		R 170
	104	Zw	2605	2775	2945	3110	3275	3440	3600		
8	112	E	1620	1725	1830	1935	2040	2140	2240		R 170
	110	Zw	3065	3270	3470	3665	3860	4050	4240		
6	102	E	1420	1515	1605	1700					T 190
	100	Zw	2675	2855	3030	3200					

5.0	5.25
-----	------

Continued
195/70 R 14 C

1730	1800	N 140
------	------	-------

See cover foldout for footnotes.

Technical data van tyres

Size	Tyre PR	Service description ⁴⁾	Rim ⁵⁾	Tyre dimensions (mm)						Radius stat. +/- 2%	Rolling circumference +1.5% -2.5%
				Max. standard value in operation ⁶⁾				new			
				Width		Outer-Ø		Width	Outer-Ø		
Stand-ard	Spe-cial	Stand-ard	Spe-cial								
16 Inch											
175/75 R 16 C	8	101/99 R	4 ½ J	179				172			
			5 J	184	678	684	177	668	308	2024	
			5 ½ J	189			182				
185/75 R 16 C	8	104/102 R	5 J	191	696	700	184	684	314	2073	
			5 ½ J	196			189				
			6 J	201			194				
195/75 R 16 C	8	107/105 R	5 J	199			191				
			5 ½ J	204	710	716	196	698	320	2115	
			6 J	209			201				
205/75 R 16 C	8	110/108 R	5 ½ J	211	726	723	203	714	328	2170	
			6 J	216			208				
			6 ½ J	221			213				
215/75 R 16 C	8	113/111 R	5 ½ J	220			211				
	10	116/114 R	6 J	225	740	748	216	728	334	2210	
			6 ½ J	230			221				
			7 J	235			226				
225/75 R 16 C	10	121/120 R	6 J	232	758	764	223	744	338	2254	
			6 ½ J	237			228				
			7 J	242			233				
195/65 R 16 C	8	104/102 T (100 T)	5 J	199			191				
			5 ½ J	204			196				
			6 J	209	670	676	201	660	305	2000	
205/65 R 16 C	8	107/105 T (103 T)	5 ½ J	212			204				
			6 J	217	682	686	209	672	308	2036	
			6 ½ J	222			214				
215/65 R 16 C	8	109/107 R (106 T)	6 J	225			216				
			6 ½ J	230	698	702	221	686	313	2077	
			7 J	235			226				
225/65 R 16 C	8	112/110 R	6 J	232			223				
			6 ½ J	237	710	716	228	698	318	2115	
			7 J	242			233				
195/60 R 16 C	6	99/97 T	5 ½ J	204			196				
		99/97 H	6 J	209	650	654	201	640	297	1939	
			6 ½ J	214			206				

See cover foldout for footnotes.

Technical data van tyres

PR	Load Index LI	Wheel position ⁷⁾	Load capacity (kg) per axle at a tyre pressure (bar)									Speed Index and reference speed (km/h)
			3.0	3.25	3.5	3.75	4.0	4.25	4.5	4.75		
8	101 99	E Zw	1140	1215	1290	1360	1435	1505	1575	1650	R 170	
			2145	2290	2430	2565	2700	2835	2970	3100		
8	104 102	E Zw	1245	1330	1410	1490	1570	1645	1725	1800	R 170	
			2355	2510	2665	2815	2965	3110	3255	3400		
8	107 105	E Zw	1350	1440	1525	1615	1700	1785	1865	1950	R 170	
			2560	2730	2900	3060	3225	3385	3545	3700		
8	110 108	E Zw	1470	1565	1660	1755	1850	1940	2030	2120	R 170	
			2770	2955	3135	3310	3485	3660	3830	4000		
8	113 111	E Zw	1590	1700	1800	1905	2005	2105	2205	2300	R 170	
			3020	3220	3415	3610	3800	3990	4175	4360		
10	116 114	E Zw	1600	1705	1805	1910	2010	2110	2210	2310	→	
			3015	3215	3410	3605	3795	3985	4170	4355		
10	121 120	E Zw	1725	1835	1950	2060	2170	2275	2385	2490	→	
			3330	3550	3765	3980	4190	4395	4605	4805		
8	104 102 100	E Zw E	1245	1330	1410	1490	1570	1645	1725	1800	T 190	
			2355	2510	2665	2815	2965	3110	3255	3400		
			1340	1430	1510	1600						
8	107 105 103	E Zw E	1350	1440	1525	1615	1700	1785	1865	1950	T 190	
			2560	2730	2900	3060	3225	3385	3545	3700		
			1465	1560	1655	1750						
8	109 107 106	E Zw E	1425	1520	1615	1705	1795	1885	1975	2060	R 170 T 190	
			2700	2880	3055	3230	3400	3570	3735	3900		
			1590	1695	1800	1900						
8	112 110	E Zw	1550	1655	1755	1855	1950	2050	2145	2240	R 170	
			2935	3130	3320	3510	3695	3880	4060	4240		
6	99 97	E Zw	1295	1380	1465	1550					T 190 H 210	
			2445	2605	2765	2920						

5.0	5.25	5.5	5.75
-----	------	-----	------

Continued
225/75 R 16 C

2595	2695	2800	2900	R 170
5010	5205	5405	5600	

Continued
215/75 R 16 C
10 PR

5.0	5.25
2405	2500
4540	4720

See cover foldout for footnotes.

Tyres for caravans and car drawn trailers

Increased load capacity of tyres on caravans and lightweight trailers (only applies to trailers with a max. speed of 100 km/h or 62 mph entered in the car registration documents).

Tyre size	LI	Max. Load capacity (kg)	Inflation pressure (bar)
PASSENGER TYRES			
80 series			
135/80 R 13	70	370	2.6
145/80 R 13	75	425	2.6
155/80 R 13	79	480	2.6
165/80 R 13	83	535	2.6
165/80 R 14	85	565	2.6
175/80 R 14	88	615	2.6
205/80 R 16 XL	104	990	3.0
75 series			
235/75 R 15 XL	109	1135	3.1
225/75 R 16	104	990	2.7
70 series			
145/70 R 13	71	380	2.7
155/70 R 13	75	425	2.7
165/70 R 13	79	480	2.7
XL	83	535	3.1
175/70 R 13	82	525	2.7
185/70 R 13	86	585	2.7
165/70 R 14	81	510	2.7
XL	85	565	3.1
175/70 R 14	84	550	2.7
185/70 R 14	88	615	2.7
195/70 R 14	91	675	2.7
195/70 R 15 Rf.	97	805	3.1
205/70 R 15	96	780	2.7
265/70 R 15	112	1230	2.7
215/70 R 16	100	880	2.7
225/70 R 16	102	935	2.7
235/70 R 16	106	1045	2.7
245/70 R 16	107	1070	2.7
265/70 R 16	112	1230	2.7

Tyre size	LI	Max. Load capacity (kg)	Inflation pressure (bar)
PASSENGER TYRES			
65 series			
155/65 R 13	73	400	2.7
165/65 R 13	77	455	2.7
175/65 R 13	80	495	2.7
155/65 R 14	75	425	2.7
165/65 R 14	79	480	2.7
175/65 R 14	82	525	2.7
XL	86	585	3.1
185/65 R 14	86	585	2.7
195/65 R 14	89	640	2.7
185/65 R 15	88	615	2.7
195/65 R 15	91	675	2.7
XL	95	760	3.1
205/65 R 15	94	735	2.7
Rf.	99	855	3.1
215/65 R 15	96	780	2.7
215/65 R 16	98	825	2.7
255/65 R 16	109	1135	2.7
235/65 R 17 XL	108	1100	3.1
60 series			
185/60 R 13	80	495	2.7
165/60 R 14	75	425	2.7
175/60 R 14	79	480	2.7
185/60 R 14	82	525	2.7
195/60 R 14	86	585	2.7
185/60 R 15	84	550	2.7
XL	88	615	3.1
195/60 R 15	88	615	2.7
205/60 R 15	91	675	2.7
215/60 R 15	94	735	2.7
225/60 R 15	96	780	2.7
205/60 R 16	92	695	2.7
215/60 R 16 XL	99	855	3.1
225/60 R 16	98	825	2.7
XL	102	935	3.1
235/60 R 16	100	880	2.7
235/60 R 18 XL	107	1070	3.1

Tyres for caravans and car drawn trailers

Increased load capacity of tyres on caravans and lightweight trailers (only applies to trailers with a max. speed of 100 km/h or 62 mph entered in the car registration documents).

Tyre size	LI	Max. Load capacity (kg)	Inflation pressure (bar)
PASSENGER TYRES			
55 series			
185/55 R 14	80	495	2.7
185/55 R 15	82	525	2.7
195/55 R 15	85	565	2.7
205/55 R 15	88	615	2.7
205/55 R 16	91	675	2.7
XL	94	735	3.1
215/55 R 16	93	715	2.7
XL	97	805	3.1
225/55 R 16	95	760	2.7
XL	99	855	3.1
215/55 R 17	94	735	2.7
225/55 R 17	97	805	2.7
XL	101	910	3.1
255/55 R 18 XL	109	1135	3.1
50 series			
195/50 R 15	82	525	2.7
205/50 R 15	86	585	2.7
205/50 R 16	87	600	2.7
225/50 R 16	92	695	2.7
205/50 R 17 XL	93	715	3.1
215/50 R 17	91	675	2.7
225/50 R 17	94	735	2.7
XL	98	825	3.1
45 series			
195/45 R 15	78	470	2.7
195/45 R 16	80	495	2.7
205/45 R 16	83	535	2.7
205/45 R 17 XL	88	615	3.1
215/45 R 17 XL	91	675	3.1
225/45 R 17	91	675	2.7
XL	94	735	3.1
235/45 R 17	94	735	2.7
245/45 R 17	95	760	2.7
225/45 R 18	91	675	2.7
245/45 R 18	96	780	2.7
245/45 R 18 XL	103	965	3.1

Tyre size	LI	Max. Load capacity (kg)	Inflation pressure (bar)
PASSENGER TYRES			
40 series			
215/40 R 16 XL	86	585	3.1
205/40 R 17 XL	84	550	3.1
215/40 R 17	83	535	2.7
XL	87	600	3.1
235/40 R 17	90	660	2.7
245/40 R 17	91	675	2.7
255/40 R 17	94	735	2.7
225/40 R 18 XL	92	695	3.1
235/40 R 18	91	675	2.7
XL	95	760	3.1
245/40 R 18 XL	97	805	3.1
255/40 R 19 XL	100	880	3.1
35 series			
255/35 R 18 XL	94	735	3.1
265/35 R 18	93	715	2.7
235/35 R 19 XL	91	675	3.1
255/35 R 19 XL	96	780	3.1
245/35 R 20 XL	95	760	3.1
235/35 R 20 XL	97	805	3.1

Tyres for caravans and car drawn trailers

Increased load capacity of tyres on caravans and lightweight trailers (only applies to trailers with a max. speed of 100 km/h or 62 mph entered in the car registration documents).

Tyre size		LI	Max. ** Load capacity (kg)	Inflation pres- sure (bar)
COMMERCIAL-C-TYRES *				
175	R 14 C	99	815	4.5
185	R 14 C	102	895	4.5
195	R 14 C	106	1000	4.5
165/70	R 14 C	89	610	3.75
195/70	R 14 C	101	865	4.75
175/65	R 14 C	90	630	3.75
185	R 15 C	100	840	3.75
		103	920	4.5
195/70	R 15 C	104	945	4.5
205/70	R 15 C	106	1000	4.5
225/70	R 15 C	112	1175	4.5
205/65	R 15 C	102	895	3.75

Tyre size		LI	Max. ** Load capacity (kg)	Inflation pres- sure (bar)
COMMERCIAL-C-TYRES *				
185/75	R 16 C	104	945	4.75
195/75	R 16 C	107	1025	4.75
205/75	R 16 C	110	1115	4.75
215/75	R 16 C	113	1210	4.75
		116	1315	5.25
225/75	R 16 C	121	1525	5.75
195/65	R 16 C	104	945	4.75
205/65	R 16 C	107	1025	4.75
215/65	R 16 C	109	1080	4.75
225/65	R 16 C	112	1175	4.75
195/60	R 16 C	99	815	3.75

*) 14, 15 and small 16 inch C tyres with treads like pass. car tyres for service on delivery vans.

) also for C tyres: Load capacity **per tyre (single fitment)

Conditions of use:

An increase of 10% resp. 5% for C tyres over the load capacity as quoted in these tables is permitted when tyres are fitted to caravans and light trailers with a maximum operating speed up to 100 km/h (62 mph). The basic inflation pressure should be increased by 0.2 bar, as quoted in these tables.

The rim is the part of the wheel which supports the tyre.

1. Important elements of the rim

Rim flange = lateral support for the tyre bead

Flange distance = clear rim width

Bead seat = base on which the tyre bead is seated

Well = inner side of the rim

Diameter = specified diameter
flange/bead seat

Hump = continuous raised section of the rim bead seat which enables a better fitting of tubeless tyre beads at **low pressure.**¹⁾

2. Types of rims

The well-base rim is virtually the only type of rim used on cars, caravans and other car trailers:

Well-base rims = one-piece rims, deepened well for easier tyre fitting, 5° tapered bead seat, "X" in the wheel size designation.

Virtually only J and B versions of the well-base rim are used and these are explained here in more detail.

If rubber valves (snap-in type) are used on rims for higher speeds, these must be fitted with **valve supports** where necessary. Also refer to the section "Fitting the tyre".

3. Wheel disc (nave)

The wheel disc is the linking element between the rim and the axle hub. Of all the measurements for wheel linking elements – centre bore and bore diameter, bolt hole type and **offset depth** – the latter is a particularly important factor for the free movement of the tyre in any wheel position.

(Offset depth = 0, when the rim centre and hub contact area of the wheel disc are in line).

4. Wheel strength

The wheel manufacturer must confirm that the wheel strength is adequate for each particular application.

5. Lateral and true running of the wheels (without tyres)

On cars which are virtually all able to considerably exceed 100 km/h (62 mph), it is particularly important that the wheels of the vehicle are **well-centred**.

There should be as little radial and lateral run-out as possible on both bead seat/flange sides of the rim, in order to achieve **good smooth running**.

The standard shows max. tolerances of 1.20 mm. This dimension is for the centre of the tyre seat area or the centre of the flange height. All measurements, particularly the **uniformity**, should be well within these tolerances.

¹⁾ Safety shoulders (e.g. hump) are prescribed for tubeless radial car tyres. They should also be used for tubeless truck C tyres with a 14, 15 or 16 code for the rim diameter.

Car rims

R_4 and R_5 : between 4 and 10 mm
 R_5 : not larger than 10 mm

Valve Hole-Ø:

11.5 mm ($11.3_{-0}^{+0.4}$) centrally in the side of the rim well.
 16.0 mm ($15.7_{-0}^{+0.4}$) only with Ø-Code 15.

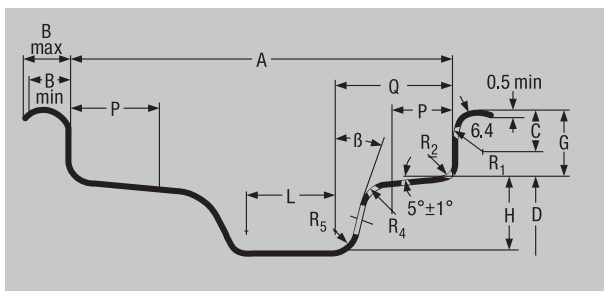

Rim Contour	Dimensions (mm)													
	A	B		G	P	H	L	Q	R ₁	R ₂	β			
		Min	Max 1)	± 0.6	Min	Min 2)	Min	Max	Min	Max	Min			
3.00 B	76	10	13	14.1	13	15	16	28	7.5	4.5	10°			
3.50 B	89				15		34							
4.00 B	101.5				19.5		45							
4.50 B	114.5													
5.00 B	127													
5.50 B	139.5													
6.00 B	152.5	± 1	15	17.3	13	17.3	16	28	9.5	6.5	20°			
3 J	76				15		34							
3 1/2 J	89				19.5		45							
4 J	101.5													
4 1/2 J	114.5													
5 J	127													
5 1/2 J	139.5				± 1.5		15	17.3				19.5	22	45
6 J	152.5													
6 1/2 J	165													
7 J	178													
7 1/2 J	190.5													
8 J	203													
8 1/2 J	216													
9 J	228.5													
9 1/2 J	241.5													

1) B max. values may be exceeded on rims for light commercial vehicles

2) Minimum dimensions for well depth (H) and well angle are required for tyre mounting

Rim diameter

Code (ins)	12	13	14	15	16	17	18	19	20
D (mm)	304.0	329.4	354.8	380.2	405.6	436.6	462.0	487.4	512.8

Special rim executions for passenger cars

In many countries **safety rims** must be used for tubeless radial tyres.

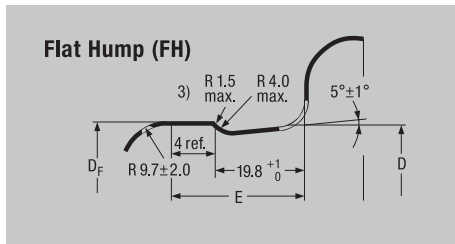
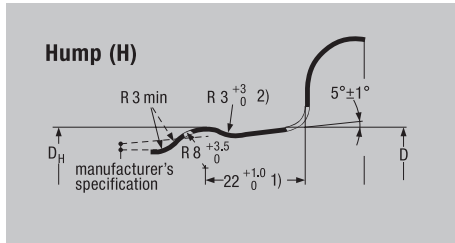

- 1) In most car rims 19.8 mm.
- 2) For B-Rims R = 8.5 mm max. resp. R = 4 ± 1 mm.
- 3) Deburred

These full-drop centre rims with safety shoulders for cars, estate cars and light trucks are marked with the following codes shown after rim size designation:

- H** = one-sided round hump on outer shoulder (formerly: H 1)
- H 2** = double round hump
- FH** = flat hump on outer shoulder (formerly: FHA 1)
- FH 2** = double flat hump (formerly: FHA 2)
- CH** = combination hump = flat hump on outer shoulder, round hump on inner shoulder (formerly: FHA-H)
- SL** = special ledge
- EH 2** = Extended Hump (with extended hump on both sides) (see following page)

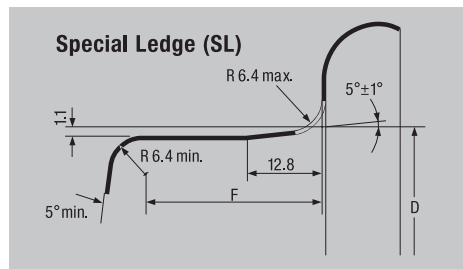

Ledge	Rim diameter Code (ins)	Dimensions (mm)		
		H	FH	
		Circumference $\pi \cdot D_H$ (+ 0 / - 3)	Circumference $\pi \cdot D_F$ (+ 0 / - 3)	E Max.
B	12	957.6	-	-
	13	1037.0	1034.8	24.5
	14	1116.8	1114.6	
J	13	1037.0	1034.8	28.5
	14	1116.8	1114.6	
	15	1196.6	1194.6	
	16	1276.4	1274.2	
	17	1373.8	1371.6	
	18	1453.6	1451.4	
	19	1533.4	1531.2	
	20	1613.2	1611.0	

Extended Hump – with extended hump on both sides (EH 2)

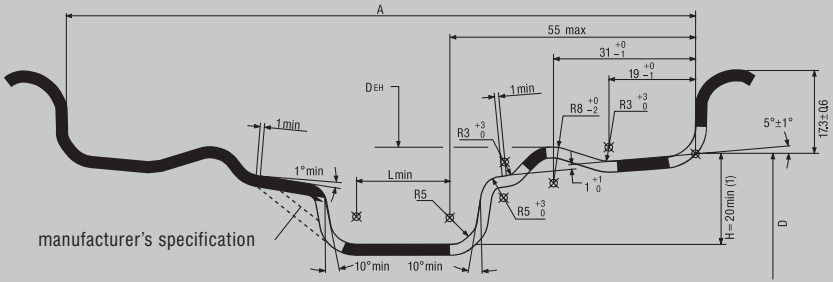

This contour is valid for rim sizes from 5 1/2 J up to 13 1/2 J

(1): H ≥ 22 necessary for automatic fitting two beads at once

Extended Hump – with extended hump on both sides (EH 2+)

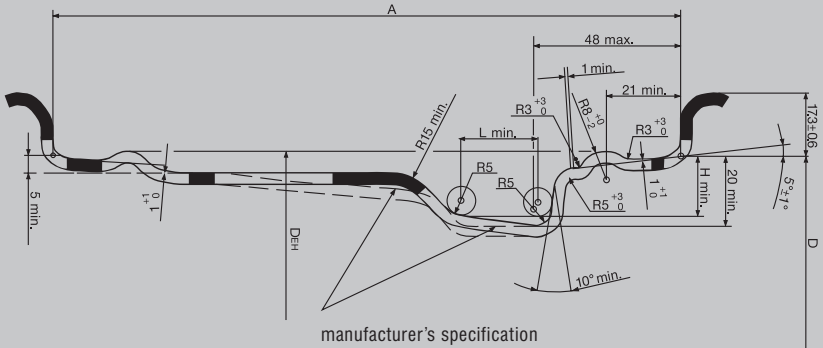

Extended Hump circumference

Rim diameter Code (ins)	Extended Hump Circumference (mm) $\pi \cdot D_{EH} (+0/-3.0)$
15	1204.2
16	1284
17	1381.2
18	1461
19	1540.8
20	1620.6

SAFETY WARNING!



The following instructions must be observed to ensure vehicle safety at all times. Disregarding the fitting instructions could endanger the safety of the tyre fitter or driver. This applies in particular to inflation pressure. Non-compliance with these

instructions means risking tyre damage which, if serious enough, may result in a tyre bursting. It is an hazard like this that can cause traffic accidents involving vehicle damage and/or serious personal injury.

Correct choice of tyre and wheel

Tyres can be properly maintained only if they are chosen in accordance with vehicle documents and recommendations of the tyre manufacturer. The use of **higher grade tyres** of the same size is permitted: Higher Speed Index, i.e. "H" instead of "T". Greater load capacity, i.e. Load Index 82 instead of 80. Both factors may be combined, i.e. greater load and speed.

If tyres are changed to a different size, all legal requirements and regulations, as well as the recommendations of the vehicle, wheel and tyre manufacturers must be complied with. In any event, the freedom of motion of the wheel and adequate load capacity of the tyre must be observed.

In some countries, tyre sizes and rims not entered in the vehicle registration document may only be fitted if the vehicle and tyre manufacturer issue a **certificate of non-objection** or if a public authority issues fitting approval after an inspection by an officially authorised expert^{*)}.

80 and 82 series passenger car tyres of the same size can be interchanged without new approval and without any new entry in the vehicle documents if LI and SI of the interchanging size are of an equivalent or higher-grade quality. Example: 155/80 R13 79 T replaces 155 R13 79 T.

Mixed tyre constructions for cars, caravans and other car trailers are not permitted: Tyres fitted on any one vehicle must all be either radial or cross-ply. (Exception: Use of the spare tyre in an emergency).

The same applies to the choice of **wheels (rims)**: The standard wheels approved by the vehicle manufacturer must be used as recommended.

The **tyre widths** given in the tables on pages 16–26 and 30–33 refer to the **measuring rim** (bold print in the tables). In the event of a change in the rim width by +½ inch, the tyre width changes by approx. +5 mm.

Winter tyres

Winter tyres are clearly superior in the cold months of the year; they offer a wider margin of safety and better economy when the temperature drops below 7 °C.

Winter tyres approved for a max. speed lower than that of the vehicle may only be fitted if the max. speed of these tyres is displayed in full view of the driver, e.g. on a clearly visible sticker on the dashboard^{*)}. This maximum tyre speed must not be exceeded.

A combination of summer and winter tyres on passenger cars is not recommended. In most European countries either summer or winter (M+S) tyres are specified for any one axle; in some countries^{**)} this applies to all four wheel positions.

Winter tyres have to meet special requirements, meaning that the legal minimum tread depth of 1.6 mm is inadequate. **The suitability limit for winter use is a tread depth of 4 mm.** In the interest of safety, Barum recommends replacing winter tyres before the tread depth drops below 4 mm for winter service. Such tyres can still be used in summer.

Top safety in winter can be provided only by true winter tyres on all axle positions (4 tyres).



Snowflake designation (in USA and Canada):

This additional marking on an M+S tyre shows that the tyre meets prescribed test criteria and ensures good winter properties.

^{*)} This does not apply to the UK.

^{**)} Exception: In Austria, passenger car winter tyres with less than 4 mm remaining tread depth are no longer legally considered to be winter tyres.

Operating instructions

Fitting the tyre

SAFETY WARNING!



If a tyre is not properly fitted it may burst. The energy released in a blow-out can cause fatal injuries so tyres must be fitted by an expert. Only approved fitting tools and lubricants may be used. Observe all fitting instructions.

Before the old tyre is taken off the valve insert must be unscrewed and removed to ensure all air has escaped.

The new tyre and rim must have matching diameters and be approved as a combination suitable for the vehicle model concerned. Only rims of the correct size in perfect condition and free of rust should be used. They must not be damaged, out of shape or worn.

When fitting new tube-type tyres, always use **new tubes**. As tubes stretch in service, there is a risk of folds forming in old tubes, so re-used tubes could suddenly tear.

For safety reasons, tubeless tyres should always be fitted with a **new valve**.

If rubber valves (snap-in types) are used for tubeless tyres, the vehicle manufacturer's instructions must be complied with in all cases. A **valve support** (i.e. a stopper on the rim itself or the hubcap) should be fitted, if H, V, W, Y or ZR tyres are specified for the vehicle. This ensures that valves are not forced off at high speeds.

Always coat the tyre beads and the rim with a **fitting lubricant** recommended by the tyre manufacturer. Never use greases or other hydrocarbons for this purpose.

While the tyre is being inflated, the wheel must remain firmly secured on the mounting machine. **Never inflate an unsecured tyre**. If a loose tyre bursts, the wheel could be thrown around, causing damage.

Keep a reasonable distance from any tyre that is being inflated. Make use of a sufficiently long and

secured extension hose with an integrated pressure gauge. **Never bend over a tyre while it is being inflated!**

When fitting tubeless car tyres, care should be taken to ensure that the tyre beads coming from the well-base first clear the hump in the rim shoulder. To avoid cracks in the bead core, the "pop" pressure necessary should not exceed 3.3 bar. If the tyre does not pop into place even at this pressure, the pressure must be lowered, and the cause identified and eliminated. Then the procedure can be repeated.

Only when the tyre beads are seated correctly on the rim shoulder may the pressure be increased to achieve the required press-fit and firm grip on the rim flanges. However, this "fitting pressure" should not exceed the max. pressure given in the tables by more than 50% or be more than 4.0 bar. After this, adjust the pressure to the **operating pressure** specified by the vehicle manufacturer.

Car tyres should be **dynamically balanced** to achieve smooth running.

Fitting the wheel to the vehicle

Vehicle axle data such as toe-in, camber angle and wheel castor as well as axle alignment must be checked and, if necessary, be adjusted to within tolerances. Only then should new tyres be fitted.

When fitting a tyre, make sure that the wheel is centred on the axle hub. If necessary, re-balance the wheel electronically once it is fitted on the vehicle.

Valves should be fitted with **valve caps** – preferably with a sealing ring – as they protect the delicate **valve inserts** and the inside of the tyre.

When mounting **wheel caps and wheel trim rings**, sufficient clearance to the tyre sidewall must be maintained. The wheel cap or wheel trim ring may not come in contact with the tyre under any operating conditions (e.g. brutal braking maneuvers, fast cornering). The diameter of the wheel cap and the wheel trim ring may not extend beyond the rim flange edge. This applies in particular to tyres with rim protection (flange rib).

Directional tyres must be fitted so that they roll in the direction of the arrow on the sidewall as the vehicle moves forward.

Exception: For a short-term use as a temporary fitment spare; but revert to specified fitted position at the earliest possible opportunity!

Modern **asymmetrical tyres** are frequently non-directional. These tyres must be fitted with the sidewall 'Outside' on the outside of the vehicle so that their asymmetrical treads can be used to best effect.

Tyre pressure

SAFETY WARNING!



Incorrect tyre pressure can lead to the inside of the tyre being damaged. This can result in tyre problems or even a blow-out. Hidden tyre problems are not rectified by adjusting the tyre pressure.

Table 1:

Load capacities and tyre pressures – standard car tyres

(The tyre pressure values shown here apply to speeds up to 160 km/h (100 mph) for camber angles not greater than 2°)

Load Index	Load capacity (kg) at tyre pressure (bar)					
	2.0	2.1	2.2	2.3	2.4	2.5
68	265	275	285	295	305	315
69	270	285	295	305	315	325
70	280	290	300	315	325	335
71	290	300	310	325	335	345
73	305	315	330	340	355	365
74	315	325	340	350	365	375
75	325	335	350	360	375	387
77	345	360	370	385	400	412
78	355	370	385	400	410	425
79	365	380	395	410	425	437
80	375	390	405	420	435	450
81	385	400	415	430	445	462
82	395	415	430	445	460	475
83	405	425	440	455	470	487
84	420	435	450	470	485	500
85	430	450	465	480	500	515
86	445	460	480	495	515	530
87	455	475	490	510	525	545
88	470	485	505	525	540	560
89	485	505	525	545	560	580
90	500	520	540	560	580	600
91	515	535	555	575	595	615
92	525	550	570	590	610	630
93	545	565	585	610	630	650
94	560	585	605	625	650	670
95	575	600	625	645	670	690
96	595	620	640	665	685	710
97	610	635	660	685	705	730
98	625	650	675	700	725	750
100	670	695	720	750	775	800

Operating instructions

Table 2:

Load capacities and tyre pressures – Reinforced and Extra Load (XL) car tyres

Load Index	Load capacity (kg) at tyre pressure (bar)									
	2.0	2.1	2.2	2.3	2.4	2.5	2.6	2.7	2.8	2.9
83	360	375	390	405	420	430	445	460	475	487
84	370	385	400	415	430	445	460	470	485	500
85	385	400	415	430	445	455	470	485	500	515
86	395	410	425	440	455	470	485	500	515	530
87	405	420	435	455	470	485	500	515	530	545
88	415	435	450	465	480	495	515	530	545	560
91	455	475	495	510	530	545	565	580	600	615
92	470	485	505	525	540	560	575	595	615	630
93	485	500	520	540	560	575	595	615	630	650
94	500	520	535	555	575	595	615	635	650	670
95	515	535	555	575	595	615	630	650	670	690
96	525	550	570	590	610	630	650	670	690	710
97	540	565	585	605	625	650	670	690	710	730
98	555	580	600	625	645	665	685	710	730	750
99	575	600	620	645	665	690	710	730	755	775
100	595	620	640	665	690	710	735	755	780	800
101	615	635	660	685	710	735	755	780	800	825
102	630	655	680	705	730	755	780	805	825	850

The tyre must be inflated to the pressure specified by the vehicle and tyre manufacturer. This varies depending on the load and service conditions.

The pressure always refers to the **cold** tyre and must not be allowed to fall below this value. The pressure inside warm tyres – driving causes heat build-up – is naturally higher. So never reduce the pressure of warm tyres. Once they cool down, their pressure could fall below the specified **minimum tyre pressure**.

Tyre pressure must be checked and adjusted regularly every 14 days on the cold tyre. Don't forget the spare!

Incorrect tyre pressure causes premature and/or uneven tread wear. **Under-inflated** tyres have a higher **rolling resistance**, and this means a higher **fuel consumption**.

The tyre pressure values for car tyres given in table 1 and 2 are **minimum pressures** for speeds up to 160 km/h (100 mph). They may be increased, for example, for reasons of driving stability.

3.2 bar is the **maximum tyre pressure** on standard version car tyres up to and including Speed Index T; 3.5 bar for H-, V-, W-, Y- and ZR-, as well as M+S and XL/Reinforced tyres.

These values may not be exceeded to ensure that the structural performance of the tyres and rims is not impaired.

ZR tyres without operational code have from 160 km/h (100 mph) to 190 km/h (118 mph) inclusive the stated pressure of 2.5 bar. Then the inflation pressure must be increased by 0.1 bar for each 10 km/h (6 mph) up to 3.0 bar at 240 km/h (150 mph) under full load and maximum 2° wheel camber.

Table 3:

For **higher speeds** the **tyre pressure** should be **increased** in regard of the load capacity (see table 4, taken from the ETRTO Standards Manual):

Speed capacity of the vehicle (incl. tolerance, about 9 km/h, 6 mph) (km/h)	Speed Indices								
	Q	R	S	T	U	H	V	W	Y
	Tyre pressure * (bar)								
≤ 160	2.5	2.5	2.5	2.5	2.5	2.5	2.5	2.5	2.5
170		2.6	2.6	2.6	2.6	2.6	2.6	2.5	2.5
180			2.6	2.6	2.6	2.6	2.6	2.5	2.5
190				2.7	2.7	2.7	2.7	2.5	2.5
200					2.7	2.7	2.7	2.6	2.5
210						2.8	2.8	2.7	2.5
220							2.8	2.8	2.5
230							2.8	2.9	2.6
240							2.8	3.0	2.7
250								3.0	2.8
260								3.0	2.9
270								3.0	3.0
280									3.0
290									3.0
300									3.0

* at the maximum load of the tyre, up to 2° wheel camber

Operating instructions

Load capacity and speed

When determining the minimum tyre size necessary for a vehicle, the permitted **axle load** and the **maximum design speed** of the vehicle must be used as a basis.

The maximum load capacity of a car tyre is expressed through its **Load Index (LI)**, see page 6.

Table 4: Percentage of load capacity (%) versus speed¹⁾ (taken from the ETRTO Standards Manual)

Speed capacity of the vehicle (incl. tolerance, about 1% V _{max} + 6.5 km/h) (km/h)	Speed Index (SI)			
	H %	V %	W %	Y %
210	100	100	100	100
220	–	97	100	100
230	–	94	100	100
240	–	91	100	100
250	–	–	95	100
260	–	–	90	100
270	–	–	85	100
280	–	–	–	95
290	–	–	–	90
300 ²⁾	–	–	–	85

¹⁾ For intermediate maximum speeds, linear interpolation of the tyre load capacity is permitted.

²⁾ For speeds over 300 km/h (187 mph), the relevant inflation pressures will be agreed between vehicle and tyre manufacturers (or their national associations), taking into consideration the vehicle characteristics and the type of service.

For **ZR tyres** without operational code the maximum load capacity given in the tables applies to speeds up to 240 km/h (150 mph).

For speeds over 240 km/h (150 mph) please refer to us for load capacity and tyre pressure.

If car tyres are to be used on a vehicle with a **wheel camber** of over 2°, please check load capacity and tyre pressure with us. In the absence of such information, the following ETRTO recommendation can be used for tyres at speeds over 160 km/h (100 mph):

$$f = \frac{1}{\left[1.0 - 0.01 \times (\text{allowance for the load capacity as a \%})\right]^{1.25}}$$

The value of f for the following camber angles is shown below:

Camber angle	2°	2.5°	3°	3.5°	4°
f	1.0	1.03	1.07	1.10	1.14

For a **wheel camber** exceeding 2° and up to and including 4°, the load capacity is to be reduced linearly **from 100% to 90%**.

Instead of a reduction in tyre load capacity, **inflation pressure** may be **increased** as a function of load.

The tyre pressure calculated for the speed concerned must be multiplied by the following correction factor (f), irrespective of the actual camber angle >2°:

In general, the camber angle of vehicles should not exceed 4°.

On vehicles with speeds in excess of 270 km/h (169 mph), the camber angle should not exceed 3° including any tolerance.

The **load capacities** in the tables for car tyres can be increased if the tyres are fitted on vehicles with **the following low type-related** max. speeds if the inflation pressure is increased at the same time (taken from the ETRTO Standards Manual).

Max. speed capability	(km/h)	60	50	40	30	25
Load capacity	(%)	110	115	125	135	142
Inflation pressure increase	(bar)	0.1	0.2	0.3	0.4	0.5

Tyre damage

Most tyre damage is caused by incorrect tyre pressure, so we recommend a regular tyre pressure check every 2 weeks. When the car has been driven and the tyres are warm, it is normal for the **tyre pressure to increase**. Do not reduce extra pressure caused by a heat build-up.

A balanced, even **style of driving** is beneficial for the tyres and the environment. Harsh acceleration, braking with locked wheels and fast steering movements shorten the **service life** of tyres.

This applies equally to other types of **tyre strain** such as severe scuffing along the kerb, or driving over rough surfaces. This can cause hidden or visible **damage** to tyres.

Sudden **vibrations** of the steering wheel could point to tyre damage. All the vehicle's tyres should be checked immediately for damage.

Overstressing of tyres (excessive speed or overloading), is to be avoided. This has the same critical effect as **under-inflation** and can cause heat damage to the tyre.

The load capacity of tyres in **twinn fitment** is 1.85 times the load capacity of a single tyre.

Even wear prolongs the life of tyres. Changing the wheels from back to front and vice-versa at appropriate intervals is recommended depending on when the vehicle is serviced but approximately every 5.000 to 10.000 km (3.000 to 6.000 miles).

Changing over from winter to summer tyres presents an ideal opportunity for **rotating tyres** to different wheel positions. On front-wheel-drive vehicles, in particular, this leads to increased economy. The instructions given in the vehicle manual should be followed when rotating the tyres.

For virtually all vehicle makes, rotating the tyres from one axle to the other is permitted. In certain cases changing them crosswise (diagonally) can also be advantageous, so as to reverse their sense of rotation. **This does not apply to directional tyres**. The wheel balance should also be checked.

The high quality standard of tyres, wheels and vehicles – promoted by the above measures and recommendations – can only be ensured by **regular checks of all the relevant factors**.

Tyre Storage Recommendations

These recommendations are intended for consumers, but they are also important for tyre dealers. For commercial applications of new and waste tyres (tyre dealers and fleets), there may be more stringent and legal restrictions. Please check local regulations.

Operating instructions

Tyres are compounded to resist normal deterioration caused e.g. by sunlight, humidity and ozone. Nevertheless, stored tyres should be protected against these and other potentially damaging conditions.

The longer the storage period, the more exposure there is to potential damage.

After dismantling from a vehicle the tyres should be thoroughly cleaned and inspected for damage. Remove all stones and debris from the grooves. Chalk marking the tyres with their wheel positions (FL for Front Left, RR for Rear Right, etc.) will help to find the correct positions according the rotational plan.

General:

- DO STORE TYRES where it is clean, dark, dry and moderately ventilated.
- **Moist conditions** should be avoided. Tyres destined for retreading/repairing should be thoroughly cleaned and dried out before such operations are performed.
- DO STORE TYRES at **temperatures** not exceeding 35° C (95 F), preferable below 25° C (77 F). Direct contact with hot pipes and radiators must be avoided.
- Also deeply cold temperatures, those well below the freezing point, might lead to brittleness and tyres should be carefully warmed up before use.
- DO STORE TYRES, if outdoors, protected by an opaque waterproof covering, but avoid creating a heat box or steam bath. Ensure proper ventilation.
- DO STORE TYRES, if outdoors, where tyres are raised off the storage surface.
- **AVOID** STORING TYRES on piers, ship decks, or other unprotected areas
- **AVOID** STORING TYRES, where they can be damaged by passing objects – lawn mower, bicycle, or garden tools.
- **AVOID** STORING TYRES where the area is wet, oily, and/or greasy such as with gasoline or petroleum-based products. Also, do not store on or against sensitive surfaces where staining can take place.

- **AVOID** STORING TYRES in the proximity of chemical agents like solvents, fuels, oils, hydrocarbons, paint, acids, disinfectants, etc.
- **AVOID** STORING TYRES where subject to extreme temperatures, direct sunlight or artificial light with a high ultra-violet content. Room lighting with ordinary incandescent lamps is preferable to fluorescent tubes.
Never store them near battery chargers, ovens, or open fires.
- **AVOID** STORING TYRES on black asphalt or other heat absorbent surfaces and on highly reflective surfaces (i.e., sand or snow covered ground)
- **AVOID** STORING TYRES in the same area as an electric motor or other ozone generating source. If there is a question, check ozone levels to be sure they do not exceed 0.08 ppm.
- **Do not** use tyres as a workbench or tool stand. Soldering irons, power drill and tools can damage a tyre. **Never** put a burning cigarette on a pile of tyres.
- **Do not** store other items on top of a tyre, especially where staining of the surface would be a concern.

Loose tyres or tyres mounted on rims, but not installed on a vehicle:

- DO STORE TYRES so that tyres retain their shape.
- Mounted tyres should preferable be inflated to only 100 kPa (15 psi/1 bar).
- **Be sure to adjust the tyres to the recommended inflation pressure before mounting on the vehicle.**

Tyres installed on a vehicle in long term storage:

- If possible, store the vehicle on blocks to remove all weight from the tyres and cover the tyres to protect them from environmental exposure.

Tyres with rims

Inflated

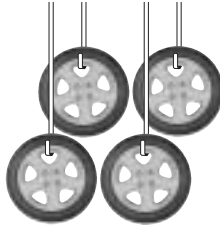

Do not stand them upright

hang them



or pile them (restack every four weeks)

Tyres without rims



Do not pile them, or hang them

stand them upright and rotate them every four weeks (on racks clear of floor)

- If the vehicle cannot be blocked up from the storage surface, completely unload the vehicle, so minimum weight will rest on the tyres. The storage surface should be firm, reasonably level, well drained, and clean.
- In cases where the tyres will be supporting the vehicle, it is permissible to inflate the tyres to the maximum pressure listed on the sidewall. Be sure to return the inflation pressure to recommended usage pressure before operating the vehicle.
- In cases where the tyres will be supporting the vehicle, it is recommended that the vehicle be moved every month to minimize ozone cracking in the bulge area and also to minimize a “flat spot” from developing. If the tyres do develop “flat spots,” this will usually disappear in a short period of service.

Before Returning Tyres (including full-size spares) to Service

- Inspect tyres to be sure they are clean and free from foreign objects.
- Remove any water that has collected in an unmounted tyre.

- When using a spare tyre, have it checked for proper inflation pressure and condition such as cracking in the tread or sidewalls, weather checking, and other signs of prolonged storage by a full-service tyre dealer, before placing it in service on the vehicle.

Full-Size Spare Tyres

Full-size spares, of the same size and type as the road tyre, require special maintenance considerations.

The spare tyre position on the vehicle is frequently not suitable for long term storage for full-size spare tyres that are not properly maintained/rotated as recommended. Tyres contain special ingredients such as waxes, etc. to protect the rubber. These special tyre ingredients normally migrate throughout the tyre when in service and protect the tyre against deterioration caused e.g. by sunlight, humidity and ozone.

Therefore, full-size spares that are left for prolonged periods of time in the spare tyre position should be inspected, properly inflated just like road tyres, and included in the regular tyre rotation.

Tyre repair



SAFETY WARNING!

Serious injury or death may result from a tyre disablement that is caused by failing to observe the following safety and maintenance information.

During its service life, a tyre undergoes a variety of different usage conditions and can be damaged in many different ways. This damage can result from punctures, impacts, cuts, etc. Tyre damage can reduce a tyre's structural integrity by, for example:

- Air loss resulting in underinflated service conditions which lead to internal structural damage;
- Direct damage to tyre components such as rubber and plies;
- Exposure of internal materials to the outside environment and resulting degradation; and/or
- Exposure of internal materials to pressurized air (Intra-carcass pressurization).

For these reasons, tyres should be regularly inspected by the consumer. An inspection of the tyres should also be incorporated during routine vehicle maintenance procedures. If tyre damage is suspected or found, it should be carefully assessed by a trained specialist immediately.

A consumer should never repair a damaged tyre. Only a trained tyre specialist who can base his assessment on a thorough and comprehensive inspection of the specific tyre can determine whether an individual tyre is suitable for repair or should be removed from service. This assessment should also take into account the complete service life history of the tyre including inflation, load, operating conditions, etc. If the tyre specialist decides to repair the tyre, then he should strictly follow all appropriate national tyre industry repair standards regarding the inspection process and repair procedures. Barum is not responsible for the specialist's decisions or the repaired tyre. Barum

advises if a tyre is returned under complaint and reason for the product's disablement is in any way associated with a repair or the reason for repair the manufacturer's warranty is invalidated.

It is forbidden by law to regroove car tyres.

Tyre service life for passenger car and light truck

The tyre industry has long recognized the consumers' role in the regular care and maintenance of their tyres. The point at which a tyre is replaced is a decision for which the owner of the tyre is responsible. The tyre owner should consider factors to include service conditions, maintenance history, storage conditions, visual inspections, and dynamic performance. The consumer should consult a tyre service professional with any questions about tyre service life.

The following information and recommendations are made to aid in assessing the point of maximum service life.

Tyres are designed and built to provide many thousands of miles of excellent service. For maximum benefit, tyres must be maintained properly to avoid tyre damage and abuse that may result in tyre disablement. The service life of a tyre is a cumulative function of the storage, stowing, rotation and service conditions, which a tyre is subjected to throughout its life (load, speed, inflation pressure, road hazard injury, etc.). Since service conditions vary widely, accurately predicting the service life of any specific tyre in chronological time is not possible.

The consumer plays an important role in tyre maintenance.

Tyres should be removed from service for numerous reasons, including tread worn down to minimum depth, damage or abuse (punctures, cuts, impacts, cracks, bulges, underinflation, overloading, etc). For these reasons tyres, including spares, must be inspected routinely, i. e., at least once a

month. Regular inspection becomes particularly important the longer a tyre is kept in service. If tyre damage is suspected or found, Barum recommends that the consumer have the tyre inspected by a tyre service professional. Consumers should use this consultation to determine if the tyres can continue in service. It is recommended that spare tyres be inspected at the same time. This routine inspection should occur whether or not the vehicle is equipped with a tyre pressure monitoring system (TPMS).

Consumers are strongly encouraged to be aware of their tyres' visual condition. Also, they should be alert for any change in dynamic performance such as increased air loss, noise or vibration.

Such changes could be an indicator that one or more of the tyres should be immediately removed from service to prevent a tyre disablement. Also, the consumer should be the first to recognize a severe in-service impact to a tyre and to ensure that the tyre is inspected immediately thereafter.

Tyre storage, stowage and rotation are also important to the service life of the tyre. More information regarding proper storage, stowage and rotation is located in other Barum publications, which are available upon request and through its websites.

Tyre service life recommendation

Barum is unaware of any technical data that supports a specific tyre age for removal from service. However, as with other members of the tyre and automotive industries, Barum recommends that all tyres (including spare tyres) that were manufactured more than ten (10) years previous¹⁾ be replaced with new tyres, even when tyres appear to be usable from their external appearance and if the tread depth may have not reached the minimum wear out depth. Vehicle manufacturers may recommend a different chronological age at which a tyre should be replaced based on their understanding of the specific vehicle application; Barum recommends that any such instruction be followed. Consumers

should note that most tyres would have to be removed for tread wear-out or other causes before any proscribed removal period. A stated removal period in no way reduces the consumer's responsibility to replace tyres as needed.

Minimum removal tread depth for passenger and light truck tyres

1.6 mm is the most widely accepted minimum tread depth standard at which tyres should be removed from service. This standard has been adopted as a regulation by many of the world's national transportation authorities. As an indication to the consumer, there are tread wear indicator bars in the main grooves of the tyre that become level with the tread surface at approximately 1.6 mm of remaining tread.

In addition to acknowledging the above, **Barum recommends** that all passenger and light truck tyres in highway motor vehicle application be removed from service at the following tread depths:

- **summer/high performance tyres=3 mm**
- **winter tyres=4 mm**

These recommendations are based upon Barum's testing as well as real world experience which shows that drivers can maintain the performance potential (e.g. wet grip) of their tyres by replacing them before they reach the **regulatory minimum tread depth of 1.6 mm**.

This applies especially to winter tyres for which winter driving properties such as snow traction are significantly reduced at tread depths below 4 mm.

¹⁾ Production code of tyres see page 5.

Guidelines on tyre safety for drivers and vehicle operators (recommended for vehicle handbooks).

Tyres need to be properly handled if they are to keep you and other road users safe. So please note the following:

1. The **tyre pressure** must be as indicated in the operating instructions for your vehicle or as marked on the vehicle itself. The pressure applies to cold tyres; it must not be any lower. Tyres that have become warm, e.g. through driving, will increase in pressure. Never release air from warm tyres, or the pressure could fall below the minimum.

The pressure must be checked **every 14 days** when the tyres are cold. Don't forget to check the spare.

If the pressure is too low, heat may build up in the tyre and lead to internal damage. **At high speeds the tread may even come off and the tyre may have a blowout.** Tyre damage that cannot be seen is not put right simply by raising the pressure afterwards!

2. Drive over **kerbstones** slowly and, if possible, at right angles. Don't drive up or against any steep or sharp-edged kerbstones or other objects (e.g. stones); this can lead to non-visible tyre damage which can cause problems later – **the tyre may fail when running at high speeds.**
3. Check tyres regularly for **damage**, such as stones, nails etc. that have penetrated the tyre, as well as any cuts, tears or bulges (in the sidewall). Foreign objects can also damage the inside of the tyre. Let your tyre dealer or specialist check to see if the tyre can be repaired. If a repair is not possible or doubtful, replace the tyre. **Damaged tyres can burst.**
4. Never fit used tyres whose 'life story' you don't know. And remember that **tyres age** even when they are little used or not used at all. If your spare tyre remains unused for years, you should only use it in emergencies and drive carefully.
5. Check the **tread depth** of your tyres regularly. The lower the depth, the greater the **risk of aquaplaning**. Ensure that your tyres comply with the legally required tread depth.

A	Ageing	51, 52	O	Offset depth	37
	Aquaplaning	52		Operating conditions	2
C	Changes in tyre size	41	Operating instructions	41–51	
	Choice of tyre	41	Operating measurements	7	
D	Dimensions	7	Operating pressure	42	
	DIN	2	Operational code	6, 16–26, 30, 32	
	Directional tyres	42, 47	Outer diameter	7, 16–26, 30, 32	
	DOT	2, 5	Overstressing	47	
E	ECE	2, 5	Overloading	47	
	ETRTO	2, 7	P	Production code	5
	EU	2		Publisher's imprint	55
F	Fitting lubricant	42	R	Regrooving	50
	Fitting pressure	42		Reinforced	5
	Fuel consumption	44		Replacing 82-series by 80	41
H	H-rated tyre	6, 42, 44, 46		Rims/Wheels	37–40
	Higher grade tyres	41		Rim codes	39
I	Increasing tyre pressure	47		Rim dimensions	38–40
	Inflation pressure/ tyre pressure	2, 7, 42–45, 52		Rim width	16–26, 30, 32
L	Load capacity	7, 16–26, 30–33, 34–36, 43–47		Rolling circumference	7, 16–26, 30, 32
	Load Index	5, 6, 16–26, 31–36, 43, 44, 46	Rolling resistance	44	
			S	Safety warning	2, 41, 42, 43
M	Max. tyre pressure	7, 44		Service life	2, 47, 50
	Max. speed	5, 6, 41, 44, 47		Sidewall marking	5
	Measuring rim	16–26, 30, 32, 41		Size ranges	8–15, 28–29
	Min. (tyre) pressure	44		Speed	2, 6, 41, 44–47
	Min. tread depth	51		Speed Index	6
	Mixed tyre fitments	41		Static radius	7, 16–26, 30, 32
N	Storage	47		Summer tyres	8–11, 28, 41, 51
	New tyres	2, 42	Style of driving	47	

Index

T	Technical data	16-26, 30-33	V	V-rated tyres	6, 42, 44, 46
	Trailers, car-drawn	34-36		Valve caps	42
	Tread depth	5, 52		Valve support	37, 42
	Tube	5		Van tyres	28-33
	Tubeless	5		Vibrations	47, 51
	TWI (Tread Wear Indicators)	5	W	W-rated tyres	6, 42, 44, 46
	Twin fitment	47		Warning	2, 41, 42, 43
	Tyre ageing	51, 52		Wheel camber	46
	Tyre damages	47, 50, 52		Wheel caps/trim rings	43
	Tyre fitting	41-42		Wheel disc	37
	Tyre markings	5		Wheels/rims	37-40
	Tyre pressure/ inflation pressure	2, 7, 42-45, 52		Winter tyres	5, 12-13, 29, 41, 51
	Tyre repairs	50	X	XL (Extra Load)	5, 44
	Tyre strain	47	Y	Y-rated tyres	6, 42, 44, 46
	Tyre width	5, 7, 16-26, 30, 32, 41	Z	ZR-rated tyres	6, 42, 44, 46
U	Under-inflation	44, 45			
	Units of measurements	7			

The content of this publication is provided for information only and without responsibility. Continental AG makes no representations about the accuracy, reliability, completeness or timeliness of the information in this publication. Continental AG may, in its sole discretion, revise the information contained herein at any time without notice.

Continental AG's obligations and responsibilities regarding its products are governed solely by the agreements under which they are sold. Unless otherwise agreed in writing, the information contained herein does not become part of these agreements. This publication does not contain any guarantee or agreed quality of Continental AG's products or any warranty of merchantability, fitness for a particular purpose and non-infringement. Continental AG may make changes in the products or services described at any time without notice.

This publication is provided on an "as is" basis. To the extent permitted by law, Continental AG makes no warranty, express or implied, and assumes no liability in connection with the use of the information contained in this publication. Continental AG is not liable for any direct, indirect, incidental, consequential or punitive damages arising out of the use of this publication. Information contained herein is not intended to announce product availability anywhere in the world.

The trademarks, service marks and logos (the Trademarks) displayed in this publication are the property of Continental and/or its affiliates. Nothing in this publication should be construed as granting any license or right to the Trademarks. Without the express written consent of Continental AG the use of the Trademarks is prohibited.

All text, images, graphics and other materials in this publication are subject to the copyright and other intellectual property rights of Continental AG and/or its affiliates. Continental AG owns the copyrights in the selection, coordination and arrangement of the materials in this publication. These materials may not be modified or copied for commercial use or distribution.

Copyright © 2009 Continental AG.
All rights reserved.

TD B 02/2009

0460 165



0460 165

www.barum-online.com

Footnotes for technical data

- 1) Instead of J-rims the same size JK- and JJ-rims may be used.
- 2) Winter tyres can be max. 1 % greater in outer diameter than standard on-road tread patterns.
- 3) At 37 mph / 60 km/h (measuring speed).
- 4) Load Index single / twin fitment and Speed Index.
- 5) Rim sizes in bold type: measuring rim.
- 6) Standard = on road tread pattern,
Special = M+S or off-road tread pattern.
- 7) S=Single / T=twin fitment.
- *) Suitable for stud application.
- ***) Studded winter tyre. Not permitted for use in countries with a ban on studded tyres. Not available in the UK.
- ****) 80 series car tyres can be used instead of 82 series tyres and vice versa, without amending the entry in the vehicle registration document. Prerequisite: LI (Load Index) and SI (Speed Index) must be equivalent in value (or higher) and meet the requirements of the vehicle documents.
- ➔ in preparation.
- ☐ being phased out.

For tyre pressures see "Operating instructions", p. 43 ff.
